

# **Rapid**

e d u c a t i o n



We bring STEM to life

[www.rapidonline.com](http://www.rapidonline.com)

Rapid Education part of the  Group



# CHEMICALS

From Acetone to Zinc powder

Vast range of chemicals available

**Rapid**  
education

[www.rapidonline.com/chemicals](http://www.rapidonline.com/chemicals)



# All you require for SCIENCE

<b>Biology</b>	<b>02</b>
<b>Chemistry</b>	<b>08</b>
<b>Laboratory Equipment</b>	<b>10</b>
<b>Physics</b>	<b>20</b>

It is said that if you turned a chemistry classroom upside down and tipped everything out, the only things that Eisco would not supply would be the chemicals themselves. The same could apply for biology, physics and all the sciences.

Eisco has been a specialist manufacturer of scientific labware for hands-on STEM activities since 1968. The company is focused on enhancing science education through cutting edge

products and technologies, and Rapid is excited to be working closely with Eisco to make these products more widely available to education customers in the UK.

The Eisco portfolio of products now available from Rapid include high quality anatomical models, scientific apparatus, lab equipment, glassware and protective clothing to cater for all the demands of the modern curriculum.

[www.rapidonline.com/eisco](http://www.rapidonline.com/eisco)



“ Eisco has been in the business of manufacturing hands on STEM activities as well as Scientific Labware for many, many years. We manufacture over 6,000 unique products across Labware, Chemistry, Physics, and Biology. As we are focused on enhancing science education through cutting edge technologies and pedagogy we are excited to work with a partner such as Rapid Education who focuses on bringing these technologies and products to market. ”



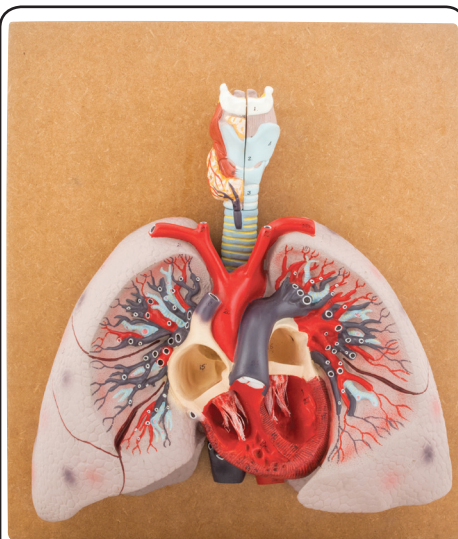

Order code  
52-3431  
**£55.95**

### Human Lungs Model with Heart and Larynx

An anatomical model showing lungs and heart in cross-section. The 2-piece larynx divides in half and can be removed for separate study.

- Mounted on base
- Major parts numbered
- Supplied with key card
- Approximate size 460 x 400 x 130mm
- Approximate weight 2.84kg
- **Eisco type AM00710**



Order code  
52-3389  
**£24.95**

### Life Size Digestive System

This hand-painted life-size anatomical model of the human digestive system shows the nose, mouth cavity, pharynx, oesophagus, the gastro-intestinal tract, liver with gall bladder, pancreas, spleen, duodenum, and opened caecum and rectum.

- Transverse colon is removable
- Model is mounted on a base
- Structures numbered, supplied with key card
- **Eisco type AM0094**



Order code  
52-3390  
**£24.95**

### Kidney and Adrenal Gland Model

This high quality, two-part human kidney and adrenal gland model shows fine details of the human kidney.

- Two hand-painted parts
- Approximate size: 120 x 120 x 280mm
- Approximate weight 400g
- Major structures are numbered
- Supplied with key card
- **Eisco type AM0110**



Order code  
52-3509  
**£25.95**

### 300x Life-Size Human Skin Model

This 300 times life-size model represents a comprehensive cross-section through human skin. It shows details of the three layers, sebaceous and sweat glands, hair follicles, erector muscles, arteries, nerves, veins and more.

- 300 times life-size
- Mounted on a base
- Many structures are numbered
- Supplied with numbered key card
- Hand painted
- **Eisco type AM0318**

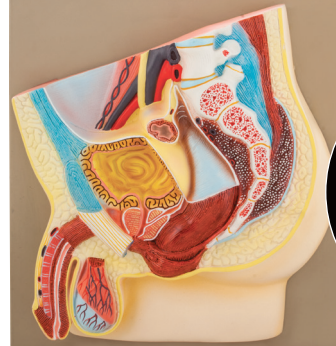

Order code  
52-3510  
**£37.95**

### Human Male Pelvis Model

This life-sized, hand-painted model shows a vertical section through the pelvic region of a human male. The model shows in detail the rectum, bladder, prostate, testicular ducts and genital organs.

- Mounted on a base
- Structures are numbered with a key card
- Hand painted model
- Natural sized
- **Eisco type AM0118**

Order code

52-3507

**£39.95**



### Seven-Part Human Heart Model

This hand-painted heart model is mounted on a supporting base and separates into seven parts.

It is sectioned such that both ventricles and atria open to expose the heart valves. Large blood vessels near the heart and musculature of the heart are also shown. Major parts of the model are numbered and listed on the accompanying key card.

- Hand-painted
- Separates into 7 parts
- Includes key card
- **Eisco type AM0073**



Order code

52-3508

**£72.95**

### Human Pregnancy Pelvis Model with Removable Fetus

A hand-painted model of the pelvic region of a pregnant human female. The model shows the 9th month of pregnancy and is an excellent model for the study of the normal position of a child before birth.

- Fetus is removable
- Key card for numbered structures
- Approximate size: 420 x 230 x 420mm
- Approximate weight 3.7kg
- **Eisco type AM0120**



To see our full range of Biology products visit [www.rapidonline.com/biology](http://www.rapidonline.com/biology)

### Urinary Organs - Kidney with Bladder Model

This life-size hand-painted model shows the kidneys, ureters, adrenal glands, bladder, and prostate.

One kidney is sectioned to show the internal details.

- Life-size
- Mounted on a base
- Parts are numbered
- Supplied with corresponding key card
- **Eisco type AM0112**

Order code

52-3513

**£24.95**



### Chromosome Model

This model of a chromosome provides help in studying its various features.

- Mounted on stable base
- Numbered, with key card
- Size 490 x 300 x 470mm approx.
- Weight approx. 1.7kg
- **Eisco type AM0115D**

Order code

52-3514

**£37.95**



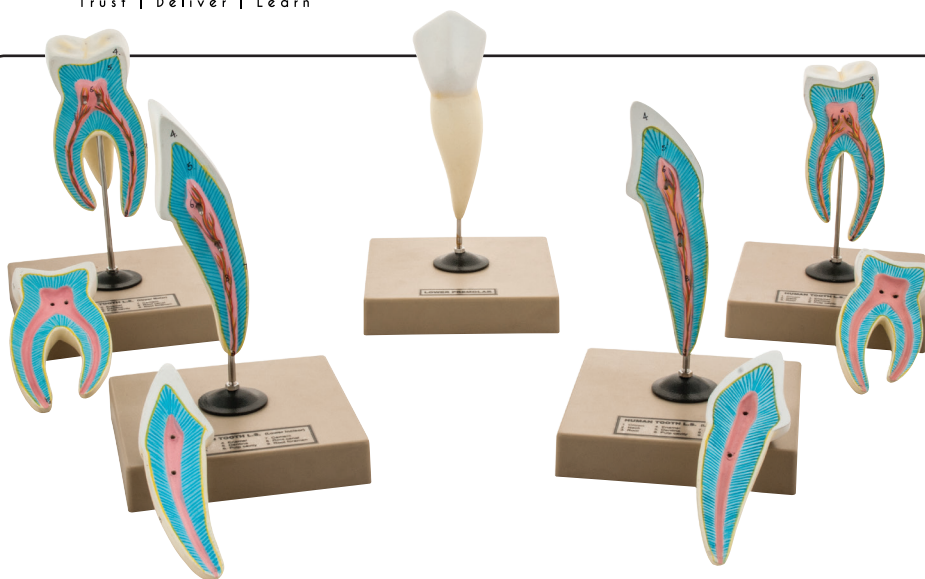

## Classic Tooth Model Series

A set of five different models illustrating every major tooth type.

- The lower incisor features a removable half of the crown
- The lower canine separates into two longitudinally
- The lower molar with one root is one-piece
- The lower molar with two roots separates into three parts showing dental caries various stages
- The first upper molar with three roots separates into three parts
- Each model is 8x life size and is mounted on its own stand with base
- Supplied as a set of 5 with English key card
- Eisco type AM0047

Order code  
52-3345

**£46.95**

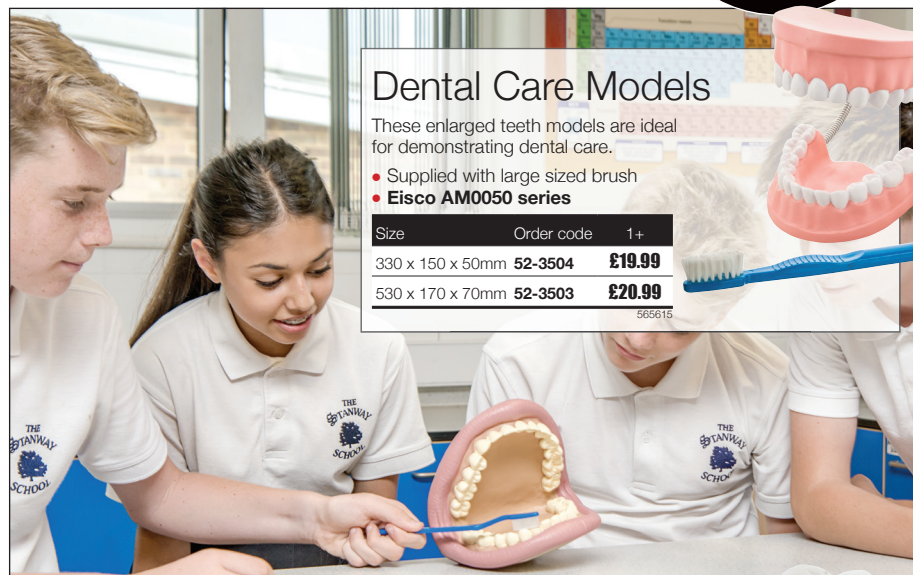

### Dental Care Models

These enlarged teeth models are ideal for demonstrating dental care.

- Supplied with large sized brush
- Eisco AM0050 series

Size	Order code	1+
330 x 150 x 50mm	52-3504	£19.99
530 x 170 x 70mm	52-3503	£20.99

565615

## Two-Part Tooth Model – Upper Triple-Root Molar with Caries

This hand-painted 15x life-size molar tooth model shows the finest details of an upper triple-root molar tooth with caries.

It separates into two longitudinal sections through the crown, two roots and pulp cavity.

- Hand-painted model
- Stable base
- Enlarged 15x life-size
- Major parts are numbered
- Supplied with corresponding key card
- Eisco type AM0046

Order code  
52-3512

**£15.95**



## Five-Part Human Ear Model

This four-times life-size, hand painted human ear model has five removable parts: the petrous portion of the temporal bone section of the auditory canal, labyrinth, tympanic membrane with malleus and incus.

- 4x life-size
- Hand painted
- 5 parts
- Major parts are numbered
- Supplied with key card
- Eisco type AM0042

Order code  
52-3511

**£44.95**



## Four-Part Human Brain Model

A high quality, four-piece, hand-painted model, showing fine details of human brain anatomy.

- 4 hand-painted parts
- Supplied with numbered key card
- Approximate size: 190 x 150 x 150mm
- Approximate weight 850g
- Eisco type AM0020

Order code  
52-3506

**£32.95**

**6 days per week  
phone orders**

Monday to Friday 8am to 7pm  
Saturday 9am to 5pm



Order code  
52-3381  
**£17.95**

### 3D Human Eye Model

This high quality seven-piece, hand-painted model shows fine details of the human eye.

The upper half of the sclera with cornea and eye muscle attachments, both halves of choroids with iris and retina, lens, and vitreous humour are all removable.

- 3x life size
- Approximate size 120 x 120 x 170mm
- Major parts are numbered
- Supplied with numbered key card
- Eisco type AM0026

### Two-Part Basic Human Skull Model

This basic human skull model is made from a fibre material and is representative of the natural colour. The lower jaw is removable.

- Natural colour
- Removable lower jaw
- Eisco type AM0126



Order code  
52-3505  
**£26.49**

# Human Skeletons

A range of human skeleton models permitting detailed observation of the structure of the human body.



450mm Human Skeleton  
Order code  
52-3516  
**£29.95**



510mm Human Skeleton  
Order code  
52-3517  
**£79.00**

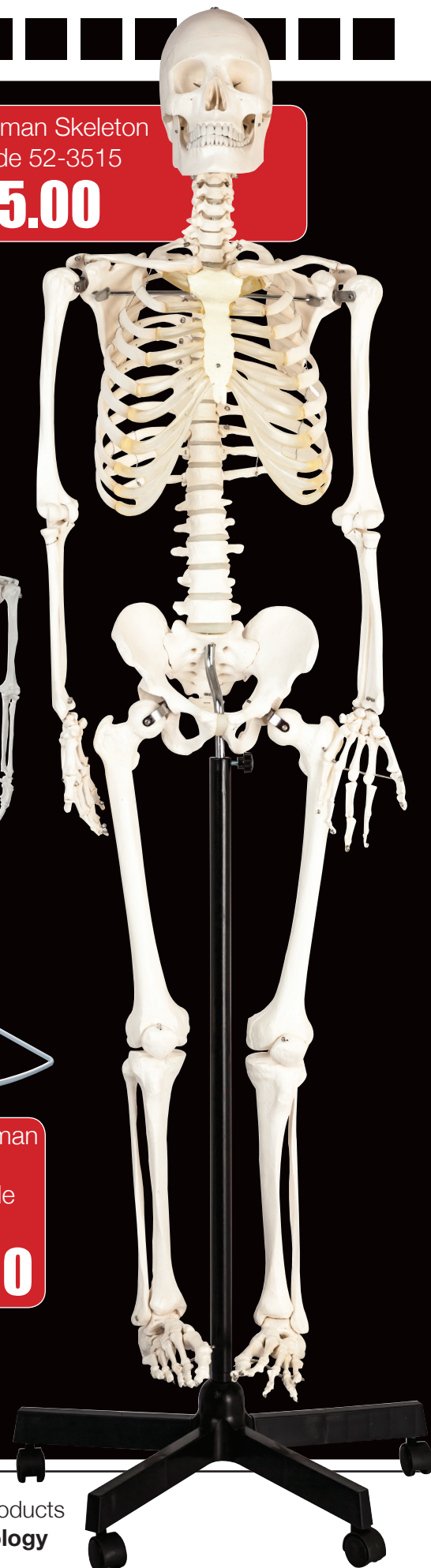

Life Size Human Skeleton  
Order code 52-3515  
**£175.00**

To see our full range of Biology products visit [www.rapidonline.com/biology](http://www.rapidonline.com/biology)

Order code  
52-3344  
**£89.95**



## Clinostat

An apparatus for the demonstration of heliotropism and geotropism in plants.

Germinating seedlings are pinned to the cork table which is rotated by an electric motor at 4 revolutions per hour. The motor is spindle-mounted and may be clamped so that the table can be positioned at any angle between horizontal and vertical.

The slow rotation in the vertical or horizontal planes cancels out the effects of gravity and directional light.

- Diameter of cork disc is approximately 100mm
- An acrylic cover protects the seedlings from draughts
- Operates from 220 to 240V AC, 50 to 60Hz
- **Eisco type BI0244**

## Bio Viewer Microslide Viewer

The Eisco Bio Viewer microslide viewer is a specially designed, precision instrument for viewing microslides.

- Does not require batteries or external power supply
- White reflector provides sufficient illumination to give a bright image in the normal light of a classroom
- Suitable for indoor and outdoor use
- 5x magnification
- **Eisco type BI0276BV**



Order code  
52-3393  
**£7.49**

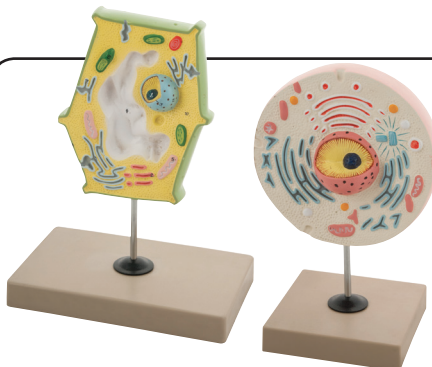

## Plant Cell and Animal Cell Models Set

These typical plant and animal cell models are ideal for comparison and contrasting between the two. They can be used to show the similarities and differences, and to point out the structures and organelle of each type.

- Plant cell is 152mm high and 125mm wide
- Animal cell is 152mm in diameter
- **Supplied as a pair**
- **Eisco type BM0050**

Order code  
52-3392  
**£39.95**



## Typical Flower Model

A large-sized model of a typical, idealised flower. The model is ideal for the detailed study of plants and as an introduction to reproduction, including angiosperm pollination and fertilization.

- Break resistant plastic
- Detachable parts and ovary containing a single ovule
- Mounted on stable base
- Numbered structures with key card
- Dimensions: 370 x 310 x 250mm
- **Eisco type BM0001**

Order code  
52-3388  
**£26.95**

## Deluxe Handheld Digital Microscope

See back page for  
more details







### Microslides

These Eisco micro-slides are strips of 8 subject-related 35mm photo-micrograph images of real slides photographed through a microscope.

- Wide range of topics
- Film strips are mounted in a clear plastic folder, for excellent protection
- Supplied in **packs of 10 strips** containing the same 8 images

Type	Order code
Cells of your body	52-3394
Digestive	52-3395
Circulatory system	52-3396
Nervous system	52-3397
Respiratory system	52-3398
Human blood system	52-3399

565567

Only  
**£34.95**  
Each



### Prepared Slides

Sets of 12 prepared microscope slides featuring bacteria or an assortment of specimens, ideal for beginners.

- Supplied as **boxed sets of 12 prepared slides**

Type	Order code	1+
Bacteria slides (12)	52-3435	<b>£8.95</b>
Beginners slides (12)	52-3473	<b>£7.49</b>

565585

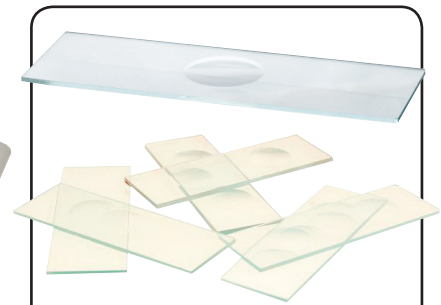

### Cavity Microscope Slides 75 x 25mm

Microscope slides manufactured from high quality glass sheets. The slides have ground and polished edges and a choice of one or two cavities for holding liquid specimens.

- One or two cavities
- Size 75 x 26mm ± 1.5mm
- Thickness 1.0 to 1.2mm
- Supplied in **packs of 10**
- **Eisco BI0086 series**

Type	Order code	1+
Single cavity	52-3471	<b>£1.99</b>
Two cavity	52-3472	<b>£3.95</b>

565604

# MICROSCOPES



### Bresser Optik Biolux USB SD-Card LCD Microscope

- 5MP CMOS sensor
- 1600x1200, 800x600 resolution
- JPEG photo formats
- 3gp video formats
- 4x, 10x and 40x lenses
- LED lighting
- USB port and SD card slot
- Mechanical stage with vernier
- USB cable
- Colour-filter glass
- Object holder and coverslip

**£162.71**

Order code 49-0525

### Celestron 44128-CGL CL-CM800 Compound Microscope

- Lab-ready compound microscope with 800x power
- 10x and 20x eyepieces with 4x, 10x and 40x objective lenses
- View specimens at 40x, 100x, 250x, 400x, 800x magnification
- Built-in, adjustable, upper and lower LED illumination

**£83.32**

Order code 52-9645



www.rapidonline.com



Only  
**£1.29**  
each

Style	Order code
Straight	52-3357
Blunt	52-3358
Curved	52-3359

## Dissecting Scissors

A range of stainless steel dissecting scissors available with various blade styles.

- Stainless steel construction



## Stainless Steel Dissecting Needles

A pack of five stainless steel dissecting needles.

- Straight style
- Length 95mm
- Supplied in packs of 5
- Eisco type BI0166A

Order code  
52-3450  
**£2.69**  
pack of 5

## Wooden Metre Stick Rulers

Metre and half-metre stick rulers made from premium grade hardwood.

- Graduated on both edges in centimetres and millimetres
- Horizontal reading
- Available in metre and half-metre lengths
- Eisco PH0064-PR series

Half Metre Stick  
Order code 52-3377

**£2.49**

Metre Stick  
Order code 52-3376

**£2.99**

## Disposable Plastic Tweezers

Disposable plastic forceps/tweezers for general purpose use in the laboratory.

- Length 110mm
- Serrated jaw tips
- Eisco type BI0177

Order code  
52-3703  
**£8.49**  
pack 12



**eisco**  
Trust | Deliver | Learn

## Kinetic Gas Theory Demonstration Apparatus

This apparatus allows students to study the motion and behaviour of molecules in gases.

An electric motor running at 4 to 12V DC vibrates a small platform inside a transparent tube, so that a number of small steel balls is vibrated violently inside the tube.

An increase in the violence of the vibration simulates an increase in gas temperature and an increase in the weight of the 'float' simulates an increase in gas pressure.

- Demonstrates kinetic gas theory
- Supplied with balls and 2 floats
- Includes instruction manual
- CE approved
- Eisco type PH0203

Order code  
52-3415  
**£24.95**



Order code  
52-3604  
**£34.95**

### Includes:

- 1x apparatus
- 2x corks
- 2x inverted test tubes
- Includes full instruction manual
- Eisco type PH0941B



## Brownlee Water Electrolysis Apparatus

Brownlee's Water Electrolysis Apparatus is used to demonstrate that electrically conductive liquids can be decomposed and resolved into their constituent elements by means of a unidirectional electric current. The gaseous components formed by this method can be trapped and their relative volumes estimated.

The apparatus consists of a support which rests on a 1 litre beaker or jar and has two clips that each hold an inverted test tube. Platinum electrodes are positioned under the inverted test tubes and are attached to insulated connecting rods which are attached to binding posts mounted on the support. When the beaker is filled with a water-based solution and a direct current is passed between the electrodes, gases will begin to collect in the inverted test tubes.

Requires a 1 litre beaker or jar, 6V battery or 10V DC power supply (not included)

Order code  
52-3610

**£9.95**

## Premium Potato Clock

This fascinating potato clock kit includes everything you need to make a potato-powered clock - apart from the potatoes themselves! The apparatus demonstrates how a clock can run without a conventional battery - using fruit, potatoes or other starchy vegetables.

- Full instructions and explanations included
- Eisco type PTCLK

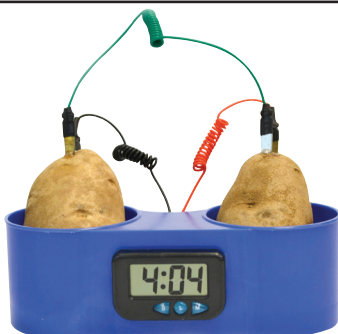

## Whitley Bay Smoke Cell

The Whitley Bay smoke cell is used for the observation of 'Brownian' or random motion in smoke particles.

It consists of a box with flanges that allow it to be easily attached to a standard microscope. The box contains a smoke cell, a cylindrical condensing lens and a 12V, 3W festoon bulb. The apparatus is pre-set to focus the light at the correct height.

- Supplied with detailed instructions and a squeeze bottle type smoke generator
- 4mm electrical connections
- Box dimensions: 90 x 46 x 20mm
- **Eisco type PH0203B**

Order code  
52-3425  
**£16.59**



### Collection

A Rock is a naturally occurring mass of minerals or mineraloids.

(I) Igneous, (M) Metamorphic

- |    |                |    |               |
|----|----------------|----|---------------|
| 1  | Basalt (I)     | 15 | Quartzite (M) |
| 2  | Gabbro (I)     | 16 | Shale (S)     |
| 3  | Granite (I)    | 17 | Slate (S)     |
| 4  | Obsidian (I)   | 18 | Siltstone (S) |
| 5  | Pegmatite (I)  | 19 | Sandstone (S) |
| 6  | Pumice (I)     | 20 | Shale (S)     |
| 7  | Anthracite (M) |    |               |
| 8  | Gneiss (M)     |    |               |
| 9  | Marble (M)     |    |               |
| 10 | Quartzite (M)  |    |               |

Order code  
52-3460

**£9.95**

## Rock Specimens

– Set of 20

A collection of 20 igneous, sedimentary and metamorphic rock specimens in a laminated die-cut box.

- Each rock is numbered corresponding to the identification list on the inside of the box lid
- Supplied as a **set of 20 rocks**
- **Eisco type BG0002D**

## Cross-Section Volcano Model

A sectional model of a volcano showing the path that magma takes on its upward course to the Earth's surface.

- Made of unbreakable coloured material
- Vertical section
- Mounted on base
- Numbered features and key card
- **Eisco type BD0082**

Order code  
52-3433  
**£74.95**

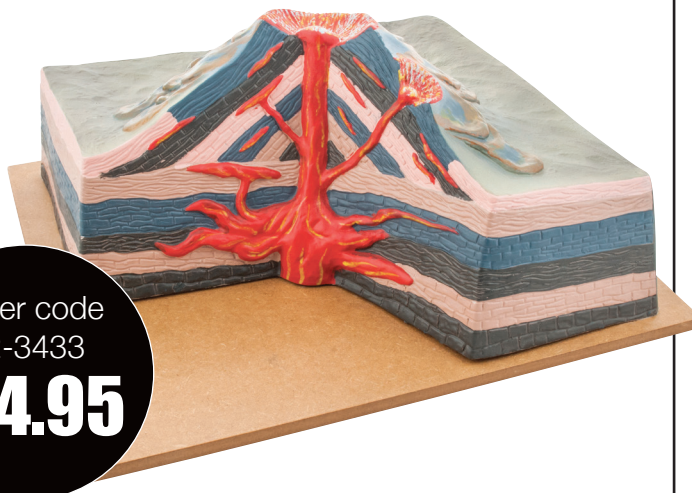

## Solid Materials Set

A selection of materials in the form of rectangular blocks, intended to familiarize students with the appearance, feel, texture, hardness and density of a range of common substances.

- Blocks, 50 x 40 x 30mm: softwood, hardwood, paraffin wax, aluminium, iron, foamed polystyrene
- Blocks, 20 x 20 x 100mm: Perspex, glass, slate, aluminium, softwood, marble
- Lead 50 x 50 x 20mm
- Aluminium 50 x 50 x 80mm
- Hardwood 50 x 50 x 200mm
- Brass 20 x 20 x 50mm
- Iron 40 x 40 x 20mm
- Supplied as a set of 34 blocks, 2 of each material
- **Eisco type PH0114**

Order code  
52-3346  
**£99.95**





### Aluminium and Copper Calorimeters

A range of calorimeters with parallel sides and a rolled rim.

- Available in aluminium or copper
- **Eisco PH0438 & PH0440 series**

*Stirrer not included.*

Metal	Size	Order code	1+
Aluminium	75 x 50mm	52-3645	£1.49
Aluminium	100 x 75mm	52-3644	£2.29
Copper	75 x 50mm	52-3647	£2.69
Copper	100 x 75mm	52-3646	£4.69

565655



### Metal Block Calorimeters

A range of metal block calorimeters that can be used for the experimental determination of the specific heat capacity of various metals.

Each cylindrical block has a mass of 1kg adjusted to an accuracy of 2%. The blocks are drilled with two holes; a larger 12.5mm central hole for a special immersion heater and a smaller hole 7.5mm diameter for a thermometer or temperature sensor.

- **Eisco PH0435 series**

Material	Order code	1+
Aluminium	52-3651	£14.49
Brass	52-3652	£24.95
Copper	52-3653	£26.95
Steel	52-3654	£9.95

565659

#### Order online

Save time, and place your order at:  
[www.rapidonline.com](http://www.rapidonline.com)  
 24 hours a day



## Hoffman's Complete Electrolysis Apparatus

Hoffman's apparatus is used for demonstrating the decomposition of water, determination of chemical composition by electrolysis and has applications in the evaluation of the electrochemical equivalent of hydrogen.

The glass unit has two connected limbs, each of approximately 50ml capacity (graduated 2 to 50ml), integral reservoir tube and funnel-shaped bulb, with a PTFE stopcock at the top of each limb.

- Supplied with 2 carbon and 2 platinum electrodes
- Requires a 12V DC power supply
- Must be set up vertically using a clamp and stand (sold separately)
- Chemicals required: water, molar sodium, potassium sulphate or sulphuric acid
- **Eisco type CH0740B**

*Stand sold separately*

Hoffmans Apparatus  
 Order code 52-3343

**£54.95**

Support Stand  
 Order code 52-3437

**£11.49**



Order code  
 52-3438

**£49.99**



### Polypropylene Measuring Jugs

A range of clear polypropylene measuring jugs with good chemical resistance.

- Graduations every 10ml
- Can be autoclaved
- **Eisco CH0356 series**

Capacity	Order code	1+
250ml	52-3373	<b>£0.79</b>
500ml	52-3374	<b>£1.35</b>
1000ml	52-3375	<b>£1.59</b>

56552



### Pipette Pumps

A range of fast-release pipette pumps for precise and quick dispensing.

A knurled thumb wheel can be rotated to draw up or dispense liquids, or the release lever can be pushed in for quick emptying. The moulded chuck has a silicon rubber collet inside to hold various standard sized pipettes. The pump resists acids and alkalis and can be easily disassembled for thorough cleaning.

- Knurled thumb wheel
- Quick release lever
- Holds various standard sized pipettes
- Resistant to acids & alkalis
- Can be disassembled for cleaning
- **Eisco CH0581 series**

Capacity	Order code	1+
2ml	52-3426	<b>£4.95</b>
10ml	52-3427	<b>£5.29</b>
25ml	52-3428	<b>£5.49</b>

56576



### Porcelain 12 Cavity Spotting Tiles

These laboratory spotting plates have 12 cavities and are glazed on their tops and sides.

- 12 cavities
- Material: porcelain
- Supplied in **packs of 10**
- **Eisco type CH0542B**

Order code 52-3401

**£11.95**



Order code 52-3369

**£8.49**  
pack 100

### 1ml Disposable Syringe

An individually packed and sterilised, plastic disposable 1ml syringe.

- Plastic
- Sterilised and individually packed
- Graduated
- Luer fitting
- Capacity 1ml
- Supplied in **packs of 100**
- **Eisco type BI0356A**



Order code 52-3432

**£2.95**

### Absorption Tubes 150 x 20mm (Pack of 2)

A borosilicate glass U-form absorption tube, with strong walls and side tubes. Absorption tubes are commonly used with calcium chloride or other desiccants to remove moisture from gases passed through them.

- Length 150mm
- Diameter 20mm
- Supplied in **packs of 2**
- **Eisco type CH0042C**



### Interchangeable Glassware Organic Chemistry Kit

A 9-piece set of borosilicate 3.3 glassware for organic chemistry experiments. All items use an ISO 383 standard taper 14/23 joint size for maximum versatility. The set is housed in a die-cut foam-lined storage box.

**Kit contains:**

- 1x flask, pear shaped, 50ml
- 1x still head
- 1x Liebig condenser
- 1x screw-cap adapter
- 1x receiver adaptor
- 1x air leak/steam inlet tube
- 1x dropping funnel 50ml with GP rota-flow tap
- 1x stopper
- 1x -10 to +110°C thermometer
- **Supplied as a set**
- Borosilicate 3.3 glass
- ISO 383 standard taper 14/23 joint size
- **Eisco type CH0876**

Order code 52-3439

**£37.95**



### Distilling Apparatus

A set of high quality borosilicate glassware ideal for distillation experiments.

- All joint sizes are 19/26
- **Set includes the following glass components:**
- Round-bottom boiling flask 500ml
- Still head
- Liebig condenser
- Receiver adapter
- Separating funnel with stopper
- Supplied as a set
- **Eisco type CH0890**

Please note that no tubing, heat source or stands are included.

### Fast Delivery

All orders for in-stock items received by 7pm – Monday to Friday are despatched the same day



Order code  
52-3464  
**£1.19**

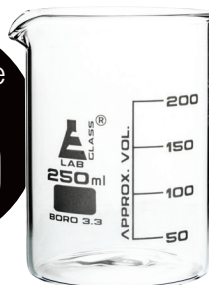

### 250ml Glass Beakers

A low form 250ml beaker made from high quality borosilicate 3.3 glass.

- Capacity 250ml
- Low form
- Supplied in **packs of 12**
- **Eisco type BK0107**

### Borosilicate Glass Filter Funnels

Borosilicate glass, plain filter funnels with 60° angled sides.

The shape of the funnels makes them ideal for use with a folded circular filter paper.

- Borosilicate 3.3 glass
- **Eisco CH0456 series**

Diameter	Order code	1+
55mm	<b>52-3465</b>	<b>£0.89</b>
75mm	<b>52-3466</b>	<b>£1.05</b>



### Porcelain Evaporating Dishes

Superior quality porcelain round-form evaporating dishes with pouring spout. The dishes are fully glazed except for the outside base.

- **Eisco CH0071 series**

Capacity	Order code	1+
80ml	<b>52-3378</b>	<b>£0.85</b>
100ml	<b>52-3379</b>	<b>£0.90</b>



### Evaporating Basins - Porcelain Flat Form with Spout

A range of porcelain flat-form evaporating basins.

- Glazed inside and outside except for rim
- Spout for easy pouring
- **Eisco CH0070 series**

Capacity	Order code	1+
35ml	<b>52-3519</b>	<b>£0.79</b>
50ml	<b>52-3520</b>	<b>£0.87</b>
100ml	<b>52-3521</b>	<b>£0.99</b>
200ml	<b>52-3522</b>	<b>£1.15</b>
300ml	<b>52-3523</b>	<b>£2.29</b>



### Porcelain Hirsch Separating Funnels

Hirsch funnels are used for straining and filtering liquids or for separating solids and liquids.

This range is made from porcelain for minimum contamination and ease of cleaning. They can be used in conjunction with filter paper for superior separation.

- Angled sides
- Glazed
- Perforated plate

Diameter	Order code	1+
30mm	<b>52-3562</b>	<b>£0.89</b>
40mm	<b>52-3563</b>	<b>£0.99</b>
50mm	<b>52-3564</b>	<b>£1.35</b>
75mm	<b>52-3565</b>	<b>£1.99</b>
100mm	<b>52-3566</b>	<b>£2.19</b>



### Crucibles - Tall

A range of tall-form porcelain crucibles and lids with ring handle.

- Glazed inside and outside except base
- **Eisco CH0074 series**

Capacity	Order code	1+
10ml	<b>52-3542</b>	<b>£0.49</b>
25ml	<b>52-3543</b>	<b>£0.62</b>
40ml	<b>52-3544</b>	<b>£0.75</b>
50ml	<b>52-3545</b>	<b>£0.89</b>
100ml	<b>52-3546</b>	<b>£1.18</b>

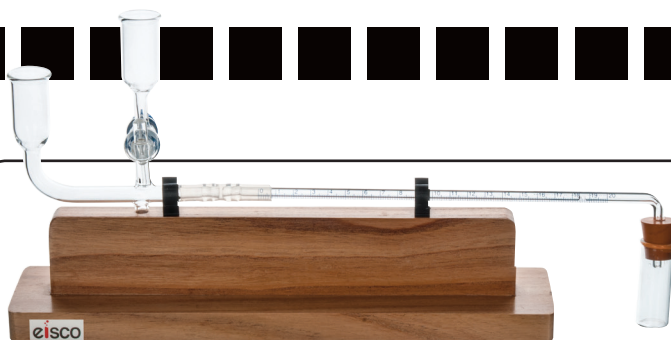

## Ganong's Potometer

A potometer is an apparatus used to measure the rate of water loss, or *transpiration*, from a plant. In the Ganong's potometer, the rate of transpiration is determined by measuring the position of an air bubble in a graduated tube over a period of time. The change in position is caused by the plant absorbing water to replace an equal volume of water lost by transpiration.

A plant shoot is sealed into a stopper which fits the end tube and the whole apparatus is filled with water, the open end of the capillary tube, which is graduated in millimetres, dipping into a beaker of water. The position of the air bubble may easily be adjusted by opening the glass stopcock to admit water from the reservoir.

The apparatus is mounted on a wooden base with the tubes held by clips.

- Height to top of reservoir 170mm
- Diameter of reservoir 20mm
- Length, overall 320mm
- Base 80 x 20mm
- Capillary bore 1 mm
- Eisco type BI0193A

Order code  
52-3493  
**£19.95**

## Potometer

A potometer is an apparatus used to measure the rate of water loss, or *transpiration*, from a plant. The rate of transpiration is determined by measuring the drop in water level in a graduated tube over a period of time. The drop in water level is caused by the plant absorbing water to replace an equal volume of water lost by transpiration.

The apparatus is mounted on a strong backing plate and consists of a capillary tube with a millimetre scale, connected via a three-way tap to a syringe. A cut shoot is connected to third outlet.

- Ideal for laboratory and field use - only one glass component, the capillary tube
- Overall dimensions 195 x 150 x 75mm
- Capillary tube 100x 1mm
- Supplied with instruction manual
- Eisco type BI0192



Order code  
52-3492  
**£14.95**



## Porcelain Mortars & Pestles

A range of porcelain mortars and pestles with unglazed grinding surfaces.

- Supplied as a set containing one mortar and one pestle

Mortar capacity	Order code	1+
60ml	52-3571	<b>£1.19</b>
275ml	52-3572	<b>£2.52</b>
550ml	52-3573	<b>£3.95</b>
900ml	52-3574	<b>£4.29</b>
1500ml	52-3575	<b>£7.39</b>
2000ml	52-3576	<b>£9.99</b>

565633



## Polypropylene Carboys

These carboys are made from polypropylene and are much lighter than glass. They are autoclavable, durable and have wide handles for easy carrying and pouring.

- Available in 10 and 20 litre capacities
- Eisco CH0065 series

Capacity	Order code	1+
10 litres	52-3526	<b>£26.95</b>
20 litres	52-3527	<b>£33.95</b>

565628



Order code  
52-3569  
**£11.45**

## Glass Tubing Cutter

This rugged laboratory glass tube cutter is made from nickel-plated, die-cast metal.

It is fitted with a spring-loaded steel wheel and can cut glass tubes up to 40mm in diameter.

- Nickel-plated, die-cast metal
- Spring-loaded steel wheel
- Cuts glass tubes up to 40mm dia.
- Eisco type CH0759SUP

## Watch Glasses - Packs of 12

Watch glasses are highly functional items of glassware that have a variety of uses in the classroom or laboratory. They work well as lids for flasks and beakers, or for holding small samples for observation under a low-power microscope. They are also ideal for evaporating liquids from samples, such as when growing seed crystals, and can be used for making lenses from ice or other liquids.

Eisco watch glasses are manufactured with sturdiness in mind. Their 2mm thick construction resists shattering and as they have ground edges, as well as a polished surface, so you can be sure that they are a safe product to handle in the classroom or the laboratory.

- Available in a range of diameters
- Eisco CH0554 series



Diameter	Order code	1+
50mm	52-3467	<b>£1.69</b>
60mm	52-3559	<b>£1.99</b>
75mm	52-3468	<b>£3.29</b>
90mm	52-3469	<b>£3.85</b>
100mm	52-3470	<b>£4.19</b>
125mm	52-3560	<b>£7.29</b>
150mm	52-3561	<b>£8.99</b>

565603



Order code  
52-3326  
**£1.79**  
Tripod

## Tripod Stand and Stainless Steel Alcohol Burner

A laboratory alcohol burner and a suitable tripod stand.

- Lamp is made from stainless steel and has a fuel capacity of 80ml
- Stand is 110mm high with an inner top diameter of 95mm
- Sold separately



Order code  
52-3325  
**£4.69**  
Alcohol burner

## Laboratory Stirring Rods

A range of general-purpose stirring rods, ideal for many jobs in the chemistry laboratory.

Policeman rod: 6mm diameter, 245mm long

Glass stirring rod: 7mm diameter, 200mm long

Button end glass rod: 7mm diameter, 300mm long

Type	Order code	1+
Policeman rod	52-3580	<b>£0.43</b>
Glass stirring rod	52-3581	<b>£1.39</b>
Button end glass rod	52-3582	<b>£2.69</b>

565636



## Wire Gauze Squares

A range of iron wire gauze squares available with or without a ceramic centre, ideal for supporting flasks, etc, while being heated on a tripod stand.

- Wire gauze with or without ceramic centre
- High quality, extra strong

Size	Ceramic centre	Pack of	Order code	1+
125x125mm	Yes	10	52-3327	<b>£5.95</b>
150x150mm	Yes	1	52-3323	<b>£0.69</b>
150x150mm	Yes	10	52-3328	<b>£6.95</b>
125x125mm	No	10	52-3567	<b>£5.29</b>
150x150mm	No	10	52-3568	<b>£6.19</b>

565518

## Pipe Clay Triangles

A range of pipe clay triangles for supporting laboratory items being heated by a Bunsen burner or other heat source.

The triangles are made of wires strung in an equilateral triangle with three hollow ceramic tubes threaded onto it. The triangle is usually supported on a tripod or iron ring and, in turn, supports a crucible, etc., allowing it to be directly heated by the flame.

- Pipe clay triangles
- Available in a range of sizes



Type	Order code	1+
50mm	52-3380	<b>£0.39</b>
60mm	52-3537	<b>£0.45</b>
75mm	52-3538	<b>£0.49</b>

565555

## Clear Acrylic Petri Dish Racks

Clear acrylic racks with white polycarbonate posts for holding and transporting petri dishes.

The racks can be very useful during inoculation, incubation and storage as the excellent visibility from all sides enables the culture to be seen and checked during incubation.

- Available in sizes to suit 60mm and 90mm dishes
- Eisco CH0376 series



Order code 52-3578  
**£24.95**  
60mm

Order code 52-3577  
**£26.95**  
90mm

To see our full range visit  
[www.rapidonline.com/laboratory-equipment](http://www.rapidonline.com/laboratory-equipment)





Order code  
52-3365  
**£6.35**  
Natural gas

Order code  
52-3366  
**£6.35**  
LPG

### 13mm Laboratory Bunsen Burners

A range of Bunsen burners consisting of a nickel-plated burner tube mounted on a die-cast base.

- Rotating air regulator
- Base diameter 80mm
- Tube diameter 13mm
- Height 142mm
- Weight 280g
- **Eisco CH0088 series**

Order code  
52-3387  
**£2.99**



### Tall Triangular Tripod 130 x 200mm

A laboratory tripod with a triangular zinc-plated, cast-iron top and mild steel legs.

- Zinc-plated cast-iron top
- Mild steel legs
- Length of side 120mm
- Height 210mm
- **Eisco type CH0645A**



### Laboratory Alcohol/ Spirit Lamps

Spirit / alcohol burning lamps ideal for smaller heating tasks in the laboratory.

- Glass or stainless steel construction
- Supplied complete with cap

Construction	Capacity	Order code	1+
Glass	120ml	<b>52-3518</b>	<b>£2.09</b>
Stainless steel	80ml	<b>52-3585</b>	<b>£3.99</b>

565626



### Extra Soft Red Rubber Tubing

Extra soft red rubber tubing, ideal for gas, water and connections to apparatus in the laboratory.

- Range of bore diameters
- Can be used at high pressure
- **Supplied in 10m lengths**

Bore diameter	Order code	1+
3mm	<b>52-3587</b>	<b>£1.29</b>
4.5mm	<b>52-3588</b>	<b>£1.69</b>
6mm	<b>52-3589</b>	<b>£2.09</b>
8mm	<b>52-3590</b>	<b>£2.34</b>
9mm	<b>52-3591</b>	<b>£2.43</b>
12.5mm	<b>52-3592</b>	<b>£3.65</b>

565637

Order code  
52-3322  
**£1.69**

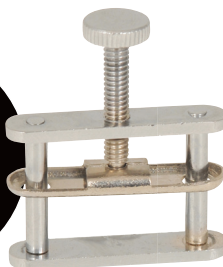

### Hoffmann Type Tubing Clamp 15mm

A Hoffman tubing clamp, ideal for compressing flexible tubing to allow variable flow regulation, particularly during chemistry experiments.

- Maximum opening 15mm
- Nickel-plated brass construction
- **Eisco type CH0298B**

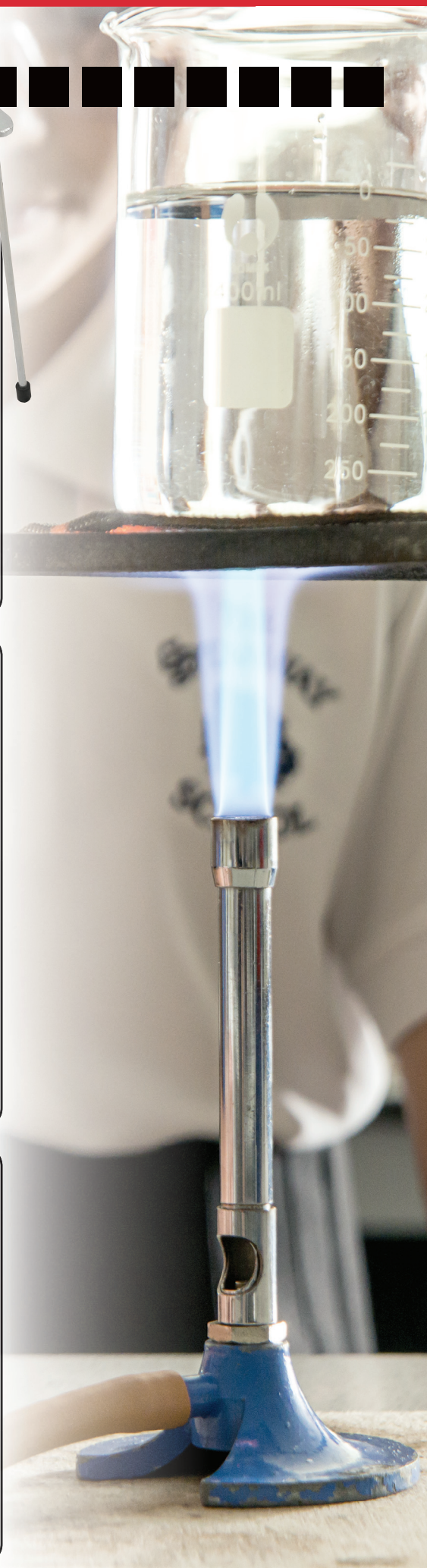



## Retort Stand Clamps and Bossheads

A range of retort stand clamps including boss-head clamps and tube clamps with rubber or cork lined jaws.

- Clamps for use with retort stands

Type	Order code	1+
Cork jaws clamp and bosshead	52-3313	£5.35
Rubber jaws clamp and bosshead	52-3314	£5.39
3 prong rubber jaws clamp	52-3367	£2.69
Economy bossheads pack of 5	52-3368	£5.35
Bosshead clamp	52-3391	£5.29

565513



## Retort Stand Rings

A range of supporting rings for use with retort stands.

The 50 and 75mm rings have built-in boss-head clamps, whereas the 150mm ring uses a separate boss-head clamp (not included) that allows the distance of the ring from the stand rod to be varied.

- 50 and 75mm rings have built-in boss-head clamps
- 150mm ring uses a separate boss-head clamp
- Eisco CH0672 & CH0668 series

Diameter	Boss-head	Order code	1+
50mm	Yes	52-3462	£1.99
75mm	Yes	52-3463	£2.15
150mm	No	52-3371	£1.99

565550

## Flask, Bottle, Burette and Beaker Brushes

A range of brushes for cleaning laboratory equipment.

Type	Order code	1+
Flask/bottle brush	52-3451	£0.75
Burette brush	52-3452	£0.99
Economy beaker brush	52-3524	£0.89
Nylon beaker brush	52-3525	£2.69

565597

## Wooden Burette Stands

Stands, designed to support up to two burettes.

The stands are made from polished seasoned hardwood, and have a separate clamping screw for each burette.

- For one or two burettes
- Polished, seasoned hardwood
- Individual clamping screws
- Rod is approx. 460 x 16mm
- Eisco CH0264 series

Order code  
52-3430

£7.39  
Single

Order code  
52-3598

£10.89  
Double



## Universal pH Test Paper

Plastic dispensers containing 5 metres of 8mm wide indicator paper. The paper is available with a range of pH 1 to pH 11 or pH 1 to pH 14. A colour comparison chart is provided on the side of the dispenser.

- Indicator paper
- Plastic dispenser
- 5m of 8mm wide test strip
- Colour chart on dispenser
- Ranges pH 1 to 11 or pH 1 to pH 14
- Eisco CH0627 series

Type	Qty	Order code	1+
pH 1 to pH 11	10	52-3400	£24.99
pH 1 to pH 14	1	52-3579	£1.72

565668



## Premium Filter Paper

Qualitative filter paper for use in the chemistry laboratory.

- Range of diameters
- Supplied in packs of 100
- Eisco CH0390 series

Diameter	Order code	1+
90mm	52-3549	£1.12
110mm	52-3550	£1.29
125mm	52-3551	£1.74
150mm	52-3552	£2.85

565630





Order code  
52-3599  
**£10.69**

### Funnel and Burette Stand

A polished wooden funnel and burette stand with clamping screws for adjusting the height and securing the burette.

- Rod approx. 460mm tall x 16mm diameter
- Base size 290 x 110mm
- **Eisco type CH0690**

*Funnel and burette not included.*



Order code  
52-3600  
**£7.39**  
Single

Order code  
52-3601  
**£11.29**  
Double

### Funnel Stands

Polished wooden funnel stands with clamping screws.

- Rod is approx. 460mm tall x 16mm diameter
- Available in single or double versions
- **Eisco CH0689 series**

*Funnels not included.*



150x150mm  
Order code  
52-3324  
**£33.95**

### Laboratory Jack

A high quality laboratory jack, ideal for accurate positioning of laboratory equipment, especially where adjustment is required.

The jack has a 10mm tapped hole in the right rear corner for accepting a suitable retort stand support rod.

- Platform size 150 x 150mm
- Maximum height 290mm
- Hole for retort rod
- Suitable for use in both the physics and chemistry laboratory
- Anodised aluminium platforms
- Large control knob
- Smooth scissor action operation
- **Eisco type CH0642C**



Order code  
52-3386  
**£5.95**  
Pack 10

### Wooden Test Tubes Holders with Spring

A 180mm long clothes peg-style, wooden test tube holder.

- Accepts 11 to 19mm diameter test tubes
- Jaws open to 32mm
- Made from wood with a metal spring
- Supplied in **packs of 10**
- **Eisco type CH0726A**

*Test tube not included.*



Order code  
52-3370  
**£12.95**  
Pack 5

### 6 Hole Test Tube Rack

A test tube rack with a wooden base and top containing a single row of 6 holes. The rack clips together quickly and easily with two moulded plastic supports.

- Height 110mm
- Takes two 30mm diameter tubes and four 20mm diameter tubes
- Supplied in **packs of 5**
- **Eisco type CH0702**

*Test tubes not included.*



Order code  
52-3449  
**£3.95**  
6 holes

Order code  
52-3448  
**£5.99**  
12 holes

### Wooden Test Tube Racks

Wooden test tube stands with 22mm diameter holes.

- Width 65mm
- Height 115mm
- **Eisco CH0704 series**

*Test tubes not included.*



View our latest videos [/rapidonline](https://www.youtube.com/channel/UC...)





Order code  
52-3434  
**£89.95**

## Laboratory Timer and Timing Gate

A precision digital timer designed to measure the time interval between any two events with high accuracy.

The timer has four operating modes: manual, free-fall mode, timing gates mode and any other triggering start and stop.

The timer has a built-in power source for timing gates and the coil for 'g' by free fall apparatus.

- Display: LED 14mm
- Suitable for use with 'g' by free-fall equipment
- Supplied with timing gates & instruction manual
- **Eisco type LBTM**



From only  
**£25.95**

## Rheostats

Useful for a variety of laboratory demonstrations, these rheostats provide a variable resistance in electrical circuits.

Oxidized constantan wire is wound on a vitreous enamelled tube.

A sliding contact carriage, mounted on the slide bar, carries a phosphor bronze contact for long life.

The rheostats have three binding posts with 4mm sockets for electrical connections: one at each end of the winding and another at the end of the slide bar.

- Available in a range of resistance values

Resistance in $\Omega$	Order code	1+
20	52-3337	<b>£25.95</b>
37	52-3336	<b>£25.95</b>
55	52-3334	<b>£25.95</b>
125	52-3335	<b>£25.95</b>

565527

# Sorting Sieves

A set of six nesting sieves with plastic frames and stainless steel mesh. The 6 sieves have varying sizes of mesh for sorting samples by particle size. Ideal for separating soil samples, etc.

- Mesh sizes:
  - #5 (4000 micron)
  - #10 (2000 micron)
  - #35 (500 micron)
  - #60 (250 micron)
  - #120 (125 micron)
  - #230 (63 micron)
- Diameter 165mm
- Complete with receiving pan and lid
- Supplied as a **set of 6**
- **Eisco type BI0139**

Order code  
52-3490  
**£44.95**  
Set of 6



Technical specification

Mesh #	Opening size (micron)	Opening size (inch)	Details
5	4000	0.151	Medium and large gravel will not pass
10	2000	0.0725	Small gravel will not pass
35	500	0.0173	Coarse sand will not pass
60	250	0.0092	Coarse and medium sand will not pass
120	125	0.0047	Very fine sand will not pass
230	63	0.0029	Fine sand will not pass, only very fine sand, silt and clay

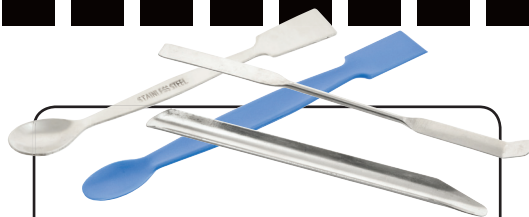

### Laboratory Spatulas, Spoons and Pick Scoops

A range of general purpose laboratory spatulas, spoons and scoops, ideal for use in the chemistry laboratory.

Technical specification

Order code	Type	Length (mm)	Qty
52-3429	Spatula with spoon	150	1
52-3372	Spatula with spoon	200	5
52-3528	Chattaway lab spatula	150	1
52-3529	Chattaway lab spatula	200	1
52-3570	Lab scoop spatula	160	6
52-3570	Polypropylene spatula with spoon	150	1
52-3584	Polypropylene spatula with spoon	200	1

Type	Order code	1+
Spatula/spoon	52-3429	£0.45
Spatula/spoon	52-3372	£2.49
Chattaway spatula	52-3528	£0.59
Chattaway spatula	52-3529	£0.69
Pick scoop spatula	52-3570	£2.95
Polypropylene spatula/spoon	52-3583	£0.26
Polypropylene spatula/spoon	52-3584	£0.33

665551

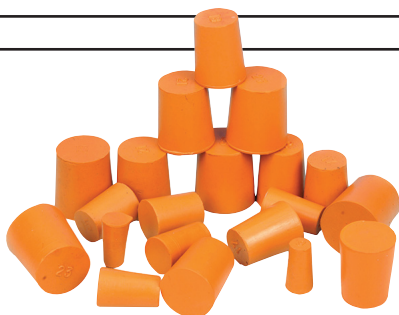

### Rubber Stoppers

A wide range of rubber stoppers with or without holes.

- Wide range of sizes
- Available with or without holes

Bottom dia.	Holes	Qty.	Order code	1+
Assorted	None	50	52-3356	£6.49
16mm	None	10	52-3420	£0.89
16mm	Yes	10	52-3421	£0.99
19mm	None	10	52-3422	£1.19
24.5mm	None	10	52-3423	£2.69
24.5mm	Yes	10	52-3424	£2.79
29mm	Yes	10	52-3440	£3.49

665541

### Deflagrating Spoon and Cap

A deflagrating spoon consisting of a steel cup and rod held by a cork in the aluminium cap.

- Steel cup and rod
- Aluminium cap
- Length 350mm
- Diameter of cap 90mm
- Diameter of cup 18mm
- Eisco type CH0520



Order code 52-3418

£1.39



Order code 52-3685

£45.95

### Light Meter

This economical light level meter has three ranges: 100, 2000 and 20,000 Lux.

- Economical
- Professional quality
- Sensor meets C.I.E. standards
- Separate probe
- Eisco type PH0629



Order code 52-3447

£1.45

### Lens Cleaning Tissue Paper

Book of 100 Sheets

Cleaning tissues suitable for cleaning laboratory lenses, prisms and mirrors as well as optical parts in cameras, spectrometers, microscopes, etc.

- Sheet size 90 x 145mm
- Supplied in books of 100 sheets
- Eisco type CH0629



Order code 52-3317

£1.49

### Triple Lens Pocket Glass Magnifier

A triple lens, folding pocket magnifier in a plastic frame. The three 10x lenses can be used individually or together to vary the magnification.

- Lens diameter 25mm
- Plastic frame
- Eisco type PH0500C



### Magnifier Glasses

High quality laboratory magnifiers.

- Chrome-plated metal frames
- Bakelite handles
- Eisco PH0510 series

Diameter	Focal length	Order code	1+
50mm	120mm	52-3674	£1.99
60mm	200mm	52-3675	£2.49
75mm	150mm	52-3676	£2.89

665607



### Moving Coil Ammeters and Voltmeters

A range of economical, fully enclosed moving coil Ammeters and Voltmeters with square clear acrylic front covers.

- Range of scales
- Ammeters and voltmeters
- Ideal for the physics laboratory
- 2.5% accuracy
- Scale length 60mm
- Overall size 125 x 80 x 80mm
- Zero adjustment
- Standard terminals - take 4mm plugs or stripped wires
- Eisco PH1074 & PH1080 series

Type	Range	Order code	1+
Ammeter	0 to 1A	52-3495	£4.95
Ammeter	0 to 2A	52-3496	£4.95
Ammeter	0 to 5A	52-3497	£4.95
Ammeter	0 to 1A/5A	52-3498	£5.29
Voltmeter	0 to 5V	52-3499	£4.95
Voltmeter	0 to 6V	52-3500	£4.95
Voltmeter	0 to 15V	52-3501	£4.95
Voltmeter	0 to 30V	52-3502	£4.95

665614



# Van De Graaff Generator

## Motor or Hand Driven

These Van De Graaff generators have been specially designed for electrostatic experiments, and where a source of high voltage is required.

The generators are mounted on a stable base along with a choice of a hand-cranked pulley or a smooth-running AC motor.

- Develop voltage up to 200kV, depending on ambient conditions
- Spark length up to 60mm
- Sphere: aluminium
- Charge collecting belt: silicon rubber with excellent insulation resistance
- Belt-tracking easily adjusted
- Acrylic shaft allows for full visibility
- Charge collecting combs: aluminium mesh, clearly visible
- Connections: 4mm sockets in dome and base
- Discharger: spherical 100mm dia., with insulated handle and 4mm sockets
- 52-3416 can be operated by hand, or from a 110 or 220V AC mains supply
- 52-3636 is operated by hand only



Order code  
52-3416  
**£149.99**  
Motor or hand

Order code  
52-3636  
**£109.99**  
Hand only



### Laboratory Resistance Units

Single resistors encased in easy-to-use plastic enclosures with 4mm terminals. These resistance units are useful for physics classroom demonstrations or experiments in electricity and electronics laboratories.

- Connect to other resistance units or circuit elements with standard 4mm leads (not included)
- Can be used with 4mm stackable plug leads, spade terminals or bared wires
- Overall dimensions: 50 x 50 x 40mm
- Eisco PH1143 series

Resistance	Order code	1+
1 Ω	52-3481	£2.49
2 Ω	52-3483	£2.49
5 Ω	52-3486	£2.49
10 Ω	52-3482	£2.49
20 Ω	52-3484	£2.49
50 Ω	52-3487	£2.49
200 Ω	52-3485	£2.49

Order code  
52-3605  
**£1.49**

### Carbon Rod

A 140mm long carbon rod with a brass terminal for electrical connection.

- Length 140mm
- Diameter 15mm
- Eisco type PH0937



Order code  
52-3606  
**£20.95**



### Daniell Cell

A set of parts for assembling a Daniell cell. The set contains a glass container, a cylindrical zinc electrode, a porous vessel and a cylindrical copper electrode.

When used with suitable liquid electrolytes (not included), a simple voltaic cell is produced.

- Eisco type PH0928



Order code  
52-3611  
**£4.95**

### Simple Cell

A simple electric cell demonstration apparatus consisting of a glass jar with zinc and copper plates connected to 4mm terminals. The addition of a suitable liquid electrolyte (not included) will produce a simple cell for use in electricity discovery experiments.

- Glass jar is 150mm tall x 100mm diameter
- Terminal plate with zinc and copper plates
- Eisco type PH0924

**FREE SCIENCE & DESIGN & TECHNOLOGY POSTERS**  
Email [education@rapidonline.com](mailto:education@rapidonline.com) for your pack

**PERIODIC TABLE**

Includes A1 Periodic Table

## Parallel Plate Capacitor Demonstration

This demonstration capacitor consists of two 120mm circular metal discs mounted on insulated supports that slide on a track to adjust the distance between them. The distance can be easily measured by reading their respective positions on the fixed scale.

The apparatus allows students to observe the principle of capacitance, its relationship with charge and voltage, its dependence on the surface area of conductors and the dielectric medium between two plates. The apparatus is supplied with three different dielectric materials: glass, cardboard, and Lucite.

- Sturdy extruded aluminium section
- **Eisco type PH0879**

Order code  
52-3635  
**£34.95**

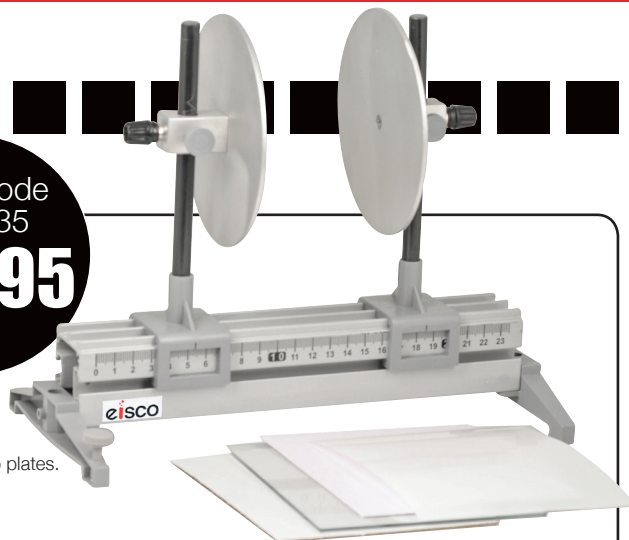

## One Metre Wheatstone Bridges

Wheatstone bridges allow accurate comparison of two resistances by sliding a 'jockey' contact along a metre length of 'resistance wire'.

When a balance is achieved, indicated by a zero reading on a galvanometer (not included), the position of the jockey on the wire, gives an indication of the ratio of the two fixed resistances. If the value of one of the fixed resistances is known, the value of the other can be inferred.

These substantial bridges have broad, heavily plated brass strips mounted on a polished hardwood base. Terminals with 4mm sockets are provided. 24 SWG constantan wire is stretched along the top of a metre scale graduated in mm and cm.

- Supplied with jockey
- Dimensions 1.13m x 80mm x 5mm approx.
- Available in 2-gap and 4-gap models
- **Eisco PH1156 series**

Type	Order code	1+
Four gap bridge	<b>52-3627</b>	<b>£29.95</b>
Two gap bridge	<b>52-3628</b>	<b>£24.95</b>

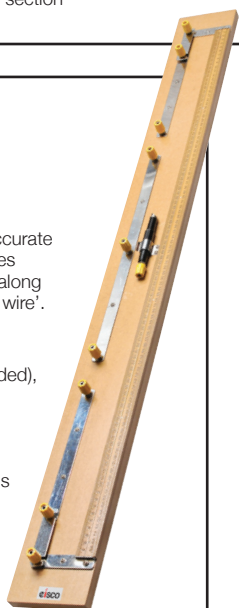

**Rapid**

...where price meets quality

Order code  
52-3310  
**£5.99**



## Electromagnet

The Eisco PH0800A electromagnet consists of a U-shaped iron core of circular section, with armature and carrying hook. It is wound with insulated copper wire and provided with colour-coded 4mm connectors.

- For use on 4 to 6V DC
- **Eisco type PH0800A**

Order code  
52-3332  
**£5.95**



## Crookes Radiometer

This radiometer consists of a partly evacuated glass bulb approximately 70mm in diameter, containing a fine pivot which supports four light weight metal arms. One side of each vane is blackened, the reverse side is bright.

On exposure to sunlight, or a sufficiently bright incandescent light source, the vanes turn. The absorption of radiant energy by the blackened side of the vanes sets up a temperature differential with respect to the bright sides, causing net force to be exerted by the air molecules on the blackened side which makes the vanes rotate with their bright faces leading.

- Approx. 70mm diameter
- Mounted on round plastic moulded base
- **Eisco type PH0418A**

## Demonstration Meter

Used to demonstrate the working principle of AC or DC ammeters or voltmeters, the meter is housed in a 300 x 150 x 30mm ABS plastic case with glass front and rear panels.

- Moving coil type
- Accuracy of  $\pm 2.5\%$
- Basic sensitivity 5mA
- 100mV f.s.d. (full scale deflection)
- **Eisco type PH1116**



Order code  
52-3338  
**£42.95**

## Demonstration Dynamo with Hand Pulley

This working model dynamo is mounted on a 200 x 125mm base plate, which also supports a 125mm diameter hand-driven pulley. The pulley is coupled, via a rubber belt, to a smaller pulley on the dynamo shaft, providing a step-up ratio of rotational speed.

Electrical output is via a pair of 4mm sockets and a light emitting diode is provided as a simple output indicator. The model can also be used as a motor when connected to a 6 to 8V DC supply (not included).

- Electrical output via 4mm terminals
- LED output indicator
- Can be used as a demonstration motor (requires 6 to 8V DC power supply)
- Includes instruction manual
- **Eisco type PH1246**



Order code  
52-3443  
**£24.95**



# Demountable Transformer Kit and Coils

A large scale transformer, ideal for classroom demonstrations. It consists of a magnetic circuit made up of highly permeable U-shaped metal sheeting which can be closed via two clamps with tightening screws.

- One coil of 600 turns, I max: 2.5A mainly used to create the transformer primary
- One coil of 1200 turns, I max: 1.25A with intermediary 400 and 800 turns outputs
- One coil of 6000 turns, I max: 0.2A with intermediary 2000 turns output
- One coil of 72 turns, I max: 12A with intermediary 6, 30, 54 and 66 turns outputs
- Magnetic core section: 40 x 40mm
- Length 150mm
- Height 170mm
- Supplied with power supply cable
- **Eisco type PH0849**

Order code  
52-3479  
**£125.95**  
Transformer kit



Turns	Current	Order code	1+
<b>Coils</b>			
50	4A	52-3474	<b>£31.49</b>
100	2A	52-3475	<b>£26.95</b>
200	1A	52-3477	<b>£26.95</b>
1000	0.3A	52-3476	<b>£26.95</b>
1000	1A	52-3480	<b>£27.95</b>
2000	0.05A	52-3478	<b>£27.95</b>

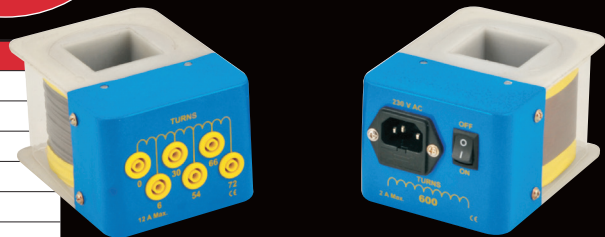

Additional coils with various numbers of turns are available separately.

## Demonstration Transformer

This low voltage demonstration transformer has various coils to show the AC voltage step-up and step-down abilities of transformers.

- Must be used with a low voltage AC source
- **Eisco type PH0976A**

Order code  
52-3609  
**£42.95**



## Transformer Accessory Set No. 1

This accessory set can be used to demonstrate that step down transformers can produce currents that are large enough to weld metals or boil water.

- **Eisco type PH0850ACC**

Order code  
52-3488  
**£34.99**

## Demonstration Motor/Generator AC/DC

This multipurpose apparatus allows students to easily compare and contrast an AC generator and a DC generator as well as an AC motor and a DC motor.

The front of the apparatus has brushes designed to collect direct current (DC) through a split ring and the back of the apparatus has brushes designed to collect alternating current (AC).

- Clever design produces AC & DC current at the same time
- Allows students to easily compare and contrast AC and DC generators and AC and DC motors
- Includes activity guide
- **Eisco type PH1245N8**

Order code  
52-3489  
**£32.95**



## Demonstration Electric Motor

A working model of a simple DC electric motor. It has a two-pole armature wound with enamelled copper wire and a permanent magnetic field provided by a removable bar magnet.

The motor has a disc-type commutator with phosphor-bronze brushes and operates from a 6 to 8V DC supply. Electrical connection is by means of a pair of 4mm sockets.

- Requires a voltage input of 6 to 8V DC
- Connection via 4mm sockets
- **Eisco type PH1238**

Order code  
52-3444  
**£15.95**

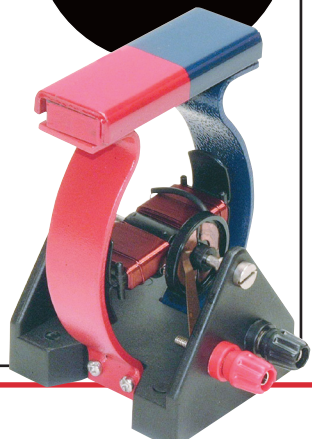



Order code  
52-3329

**£9.95**

### Snell's Law Spouting Cylinder

An apparatus for demonstrating the principle of Snell's Law, which states that pressure increases with depth.

Liquid will exit from the 3 spouts and travel further horizontally depending on the depth of liquid above them.

- 60mm diameter acrylic pipe
- 400mm total height
- 3 spouts at predetermined heights
- **Eisco type PH0196**



Order code  
52-3330

**£4.79**

### Equality of Liquids Apparatus/ Pascal's Law Syringe

An apparatus consisting of a glass flask with holes in the bulbous part and a glass piston that slides in the straight part.

When filled with liquid, the piston is pushed into the apparatus, causing liquid to exit each hole with equal pressure regardless of the hole's position or direction.

- Also known as Pascal's Law syringe
- **Eisco type PH0194**

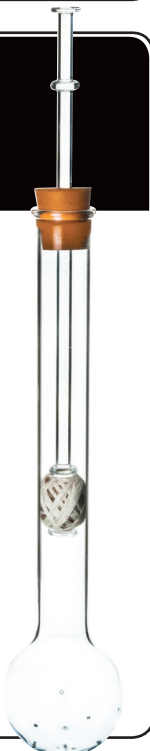

### Vacuum Pump Plate

This pump plate has been manufactured from aluminium and has a tube for connection to a vacuum pump and a stopcock for air regulation.

The plate is mounted on a heavy, painted tripod base for good stability and is supplied with a rubber seal which facilitates sealing in experiments involving bell jars.

- Diameter 250mm
- Tripod-style base for stability
- Suitable for many physics experiments involving a vacuum
- **Eisco type PH0156C**



Order code  
52-3360

**£34.95**

Order code  
52-3331

**£24.95**

### 75mm Brass Magdeburg Hemisphere Set

A practical vacuum and atmospheric pressure demonstration set consisting of two 75mm diameter brass hemispheres.

Each hemisphere has a handle firmly attached to it. One of the hemispheres has a stopcock for attaching to vacuum tubing. When the hemispheres are pushed together and evacuated using a vacuum pump they are hard to pull apart.

Get 2 students to pull, then open the stopcock to let air in and the hemispheres will separate easily to the surprise of the students.

- Made of brass
- Fitted with stopcock
- Diameter 75mm
- **Eisco type PH0172**



Order code  
52-3361

**£27.95**

### Hand-Powered Vacuum Pump

This economical vacuum pump features a gauge graduated in both cm<sup>3</sup> and inches<sup>3</sup>. Each depression of the handle displaces 15ml of air.

- Economical vacuum pump
- Gauge in cm<sup>3</sup> and inches<sup>3</sup>
- Maximum vacuum 50mm of Hg
- Can also produce positive pressures up to 2atm
- Pump rate 15ml per stroke
- Clear tubing is 600mm long with 6mm inner diameter
- **Eisco type PH0167**



Type	Order code	1+
Solar cell & motor	52-3353	<b>£24.95</b>
Solar cell only	52-3354	<b>£13.49</b>
Solar motor & fan	52-3355	<b>£9.35</b>

### Solar Cell and Motor Demo Set

A range of solar units, ideal for demonstrating the conversion of solar energy into mechanical energy.

- Range includes solar cells, solar motors, LED and buzzer



### Jolly Bulb with Gauge

This Jolly bulb apparatus consists of a 60mm diameter bulb directly connected to a bourdon pressure gauge.

The apparatus is used for investigation of gas at a constant volume. By inserting the glass bulb into either warm or cold water, the expansion or contraction of the air contained in the bulb can be seen as a pressure change on the gauge.

- 60mm diameter glass bulb
- Gauge calibrated in both kg/cm<sup>2</sup> and in psi
- **Eisco type PH0138C**



Order code  
52-3700

**£29.95**



**6 days per week  
phone orders**

Monday to Friday 8am to 7pm  
Saturday 9am to 5pm

Order code  
52-3414

**£124.99**

## Boyle's Law Apparatus

This high quality Boyle's law apparatus comes complete with accessories, including a 405mm pump with braided hose and two bottles of coloured mineral oil.

The apparatus is 685mm tall with a powder-coated metal base approximately 205 x 125mm.

- High quality pressure gauge
- 200mm braided nylon flexible hose
- Hand operated pump
- 2 bottles of coloured mineral oil
- PPE funnel
- Instruction manual
- **Eisco type PH0150A**



Order code  
52-3349

**£8.69**

## Boyle's Law Simple Form

A simple apparatus for the demonstration of Boyle's law, consisting of an airtight graduated plastic syringe with a lubricated piston, mounted between two wooden blocks.

Weights can be stacked on the top platform, compressing the gas. The corresponding measurement of volume can be read from the syringe scale.

- Air-tight plastic syringe supported between wooden blocks
- Weight on the upper block produces pressure that compresses the gas
- Volume measurements can be read from the syringe scale
- **Eisco type PH0145A**

Order code  
52-3340

**£189.99**



## Standard Spectrometer

An economically priced, high-quality, precision manufactured instrument capable of quantitative work. The main structural parts of this laboratory grade spectrometer, including the collimator and telescope bodies are manufactured from heavy castings for durability and precision. This lab-quality spectrometer offers excellent quality at a price that every classroom can afford.

### Collimator

The collimator consists of an adjustable slit on one end, with an achromatic converging lens (focal length 178mm) on the other. The lens is secured in a tube which can be adjusted by hand to ensure the slit is in the focal plane of the lens, thus producing parallel rays. Scale: 170mm diameter, 0 to 360° x 1°, capable of independent rotation, with locking screw. A spring-loaded vernier scale (attached to the telescope mount) provides readings to 0.1deg (6 minutes of arc). Collimator mounted on fixed pillar with axis adjustment.

The collimator is mounted on a spring loaded support, integral with the base.

### Prism Table

The prism table is mounted on a 175mm diameter circular degree scale. The scale can be rotated around the central axis and is provided with a clamping screw. The prism table is provided with three levelling screws and has lines marked to assist with precise placement of the prism.

### Telescope

The astronomical type telescope consists of an achromatic objective at one end and a Ramsden's eyepiece with cross wires. The position of the lens can be adjusted by hand. The telescope is mounted on heavy bearings, and can be rotated around the central axis of the apparatus. A clamping screw allows fixing of the telescope position and a tangent screw allows fine movement. A vernier scale allows the position of the telescope to be read to a precision of 0.1°.

- Quality, precision manufacture
- Diffraction grating holder
- Rotatable prism table
- Affordably priced for the classroom
- Astronomical type telescope with Ramsden eyepiece
- Supplied in durable storage box
- Includes working instructions
- Product dimensions: 420 x 310 x 280mm (16.5 x 12.2 x 11in.)
- Weight: 4.95kg (10.9 pounds)
- Standard accessories: 1-prism clamp for prisms up to 40mm high, 1 diffraction grating holder, aperture 25 x 25mm, 1 small screwdriver, 1 Tommy bar for axis adjustment
- **Eisco type PH0619**



Order code  
52-3382  
**£5.39**

### Spectroscope Kit

This industry standard spectroscope can be used for measuring light wavelengths and colours from various light sources. The spectroscope measures wavelengths from 400 to 700nm for detailed examination.

- Measures wavelengths from 400 to 700nm
- Eisco type PH100QA

### Order online

Save time, and place your order at:

[www.rapidonline.com](http://www.rapidonline.com)

24 hours a day

## Basic and Advanced Ripple Tank Kits

These ripple tank kits are supplied complete with all accessories needed for wave investigations.

Each water wave behaves similarly to a curved lens. The crest of the wave is seen as a bright region and the trough is seen as a dark region.

The ripple tanks have a mechanical vibrator attached to a wave generator that produces either point wavelets or parallel wave fronts.

- Advanced model is supplied complete with a power supply and wave controller
- Basic model requires additional power supply and controller

Order code  
52-3442  
**£209.00**  
Advanced



Order code  
52-3383  
**£69.95**  
Basic



### Diffraction Gratings

A range of transmission type diffraction gratings mounted in 50 x 50mm frames.

- Eisco PH0624 series

Lines/mm	Order code	1+
100	52-3670	<b>£16.95</b>
300	52-3461	<b>£16.95</b>
600	52-3671	<b>£16.95</b>
1000	52-3672	<b>£16.95</b>

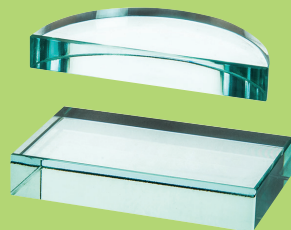

### Rectangular and Semi-Circular Glass Blocks

High quality glass blocks for use in optical and light experiments.

- Range of shapes

Type	Order code	1+
Rectangular	52-3315	<b>£3.39</b>
Semi-circular	52-3316	<b>£2.19</b>



Order code  
52-3363  
**£0.79**

### Plastic Mirrors 150 x 100mm

These Eisco plastic mirrors are ideal for science experiments dealing with reflection, symmetry and other light-related topics.

- Size 150 x 100mm
- Safe and durable
- Ideal for use by younger children
- Supplied **singly**
- Eisco type PH0517A

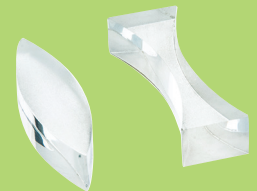

### Acrylic Lenses, Double Concave and Double Convex

Double concave and double convex lenses made from clear Acrylic.

- One plane surface is frosted
- Approximate length 85mm
- Eisco PH0577 series

Type	Order code	1+
Double concave	52-3666	<b>£6.29</b>
Double convex	52-3667	<b>£5.29</b>

### Acrylic Light/Wave Guide Demonstrator

An 'S' shaped 220 x 20 x 20mm acrylic bar which can be used in conjunction with a ray box to demonstrate total internal reflection.

- Helps students understand principles of optical communications
- Bottom of bar is white to aid visibility
- Size 220 x 20 x 20mm
- Eisco type PH0587



Order code  
52-3668  
**£5.39**

### Concave Glass Mirrors 50mm Diameter

These concave glass mirrors are ideal for light and reflection experiments.

- Concave glass mirrors
- 50mm diameter
- Focal length 100mm
- Optically worked
- Silvered back with protective coating
- Supplied in **packs of 10**
- Eisco type PH0520C



Order code  
52-3364  
**£9.49**  
Pack of 10



### Acrylic Prisms Set of 7

Order code  
52-3362  
**£19.49**



A set of seven clear acrylic blocks. The blocks are 25mm thick and are fully polished on all faces.

- Rectangle 75 x 50mm
- Semi circle 75mm dia.
- Triangle 60° x 60° x 60°, 58mm side
- Triangle 90° x 45° x 45°, 75mm hypotenuse
- Triangle 90° x 60° x 30°, 75mm hypotenuse
- Bi-convex 75mm long, curved faces 100mm radius
- Bi-concave 75mm long, curved faces 100mm radius
- Eisco type PH0571



25 x 25 x 100mm    25 x 25 x 50mm    25 x 25 x 25mm

### Acrylic Prisms

Acrylic prisms in a variety of shapes and sizes.

- Ideal for experiments with light refraction and other optical studies

Type	Order code	1+
Trapezoid	52-3669	<b>£7.29</b>
Equilateral set of 3	52-3680	<b>£3.99</b>



Order code  
52-3681  
**£10.95**

### Glass Lenses Set

An optical lens set of six 50mm diameter glass lenses. The lenses have ground and polished faces and ground edges. The set includes one of each of: double convex, plano-convex, converging concave-convex, diverging concave-concave, double concave and plano-concave.

- Glass lens set
- Lens diameter 50mm
- Wooden storage box with hinges and latch
- Eisco type PH0538A



Order code  
52-3678  
**£12.95**

### Ray Box

This traditional ray box has three openings, two of which can be used simultaneously by two sets of pupils. Only a minimum of accessories are needed to cover a wide range of optics experiments.

The two side openings each have two slots for blanking plates or 50mm slide accessories. The front opening has seven grooves for accessories and lenses. The front opening has been designed so that when used with a biconvex cylindrical lens of 75mm focal length, divergent or convergent rays are obtained through the slit plate.

- Set includes:
- Ray box with 2m flex and two 4mm plugs
- 12V, 24W, B15 bulb
- 1x slit plate
- 2x aluminium blanking plates
- Supplied with instructions
- Eisco type PH0602A

Power supply not included.

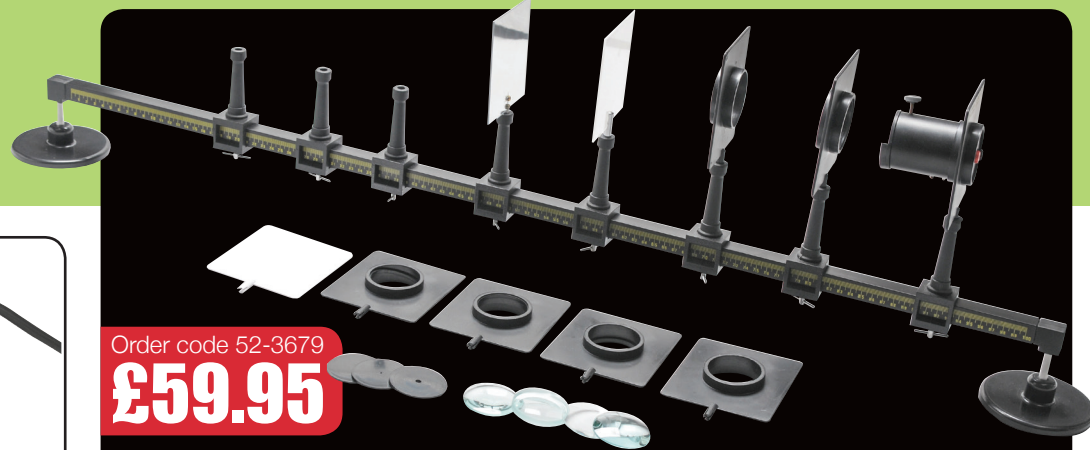

Order code 52-3679  
**£59.95**

### Enhanced Optical Bench Set

This optical bench kit includes an enhanced set of accessories allowing the user to perform more experiments than other more basic kits. The bench is 1m long and is graduated on one side.

- Eisco type PH0649

Power source for lamp not included.

#### Set includes:

- 1x 1m optical bench with end supports and graduation scale
- 8x riders with tightening screw
- 1x lamp housing with 12V, 24W halogen bulb
- 6x lens holder for 50mm dia. lenses
- 3x biconvex lenses: +10, +20 & +50
- 1x biconcave lens -20
- Set of diaphragms
- 1x plain mirror 100 x 100mm
- 1x translucent screen 100 x 100mm
- 1x transparent screen 100 x 100mm
- 1x object screen white 100 x 100mm

### Light Box and Optical Set

Order code  
52-3673  
**£39.95**

This set of optical equipment is ideal for a wide range of reflection, refraction and colour-mixing experiments.

The light box consists of a 12V, 24W light source that can produce convergent, divergent or parallel beams. On one end, the light box has an adjustable cylindrical convex lens for producing a parallel beam. On the other end, there is a triple aperture system for colour mixing experiments. The box also has lateral apertures with adjustable hinged mirrors. All apertures in the box have vertical channels to hold slit plates and colour filters, etc.

The optical set includes acrylic blocks, a set of three mirrors, two slit black plates and a set of seven mounted colour filters.

- Supplied with experiment guide
- Eisco type PH0615

Note: power supply for lamp not included.



### Wooden Lens Holder



Order code  
52-3682  
**£1.79**

A wooden holder with a V-shaped slot for supporting lenses or mirrors up to 76mm in diameter.

The holder consists of an upright 100mm high, mounted on a 100 x 50mm rectangular base. An index mark is engraved on each end of the base for easy distance measurements.

- Holds convex or concave lenses
- Dimensions: 100 x 100 x 50mm
- Eisco type PH055A



### Acrylic Lenses Set

Optical lens sets of six acrylic lenses. The lenses have ground and polished faces and ground edges. Each set includes one of each of: double convex, plano-convex, converging concave-convex, diverging concave-convex, double concave and plano-concave.

- Acrylic lens sets
- Available in sets of 38mm or 50mm diameter
- Wooden storage box with hinges and latch
- Eisco PH0538 series

Lens diameter	Order code	1+
38mm	52-3683	<b>£7.99</b>
50mm	52-3684	<b>£9.95</b>

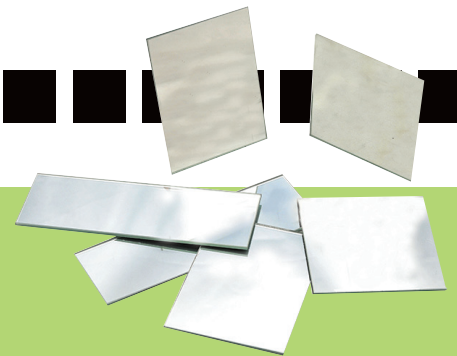

### Unmounted Plane Glass Mirrors

Silvered plane glass mirrors with a protective coating.

- Range of sizes
- Supplied in packs of 10

Size	Order code	1+
75 x 25mm	52-3688	<b>£2.29</b>
75 x 50mm	52-3689	<b>£3.19</b>
100 x 75mm	52-3690	<b>£4.95</b>
150 x 25mm	52-3691	<b>£3.49</b>
150 x 50mm	52-3692	<b>£4.89</b>
150 x 100mm	52-3693	<b>£7.95</b>

565671



### Newton's Colour Disc

Newton's colour disc demonstrates the discovery, made by Newton, that white light is composed of all the spectral colours. By rotating a multi-coloured disc at high speed, the individual colours can be seen to merge into white.

The apparatus consists of a 175mm diameter multi-coloured disc mounted on a metal stand. The disc is driven by a belt connected to a driving wheel, fitted with a crank handle.

- Disc diameter 175mm
- Eisco type PH0582A

Order code  
52-3677  
**£17.95**



### Primary and Secondary Coloured Filters

Sets of six coloured plastic sheets. Three sheets feature primary colours, three feature secondary colours.

- Coloured plastic sheets with or without mounts
- Supplied as sets of 6

Type	Order code	1+
50x50mm, mounted	52-3686	<b>£4.79</b>
100x100mm, unmounted	52-3694	<b>£4.19</b>

565600



Order code  
52-3687  
**£13.95**

### Pin Hole Camera

The concept of the pin-hole camera is centuries-old. This model consists of a telescopic wooden box with a pinhole in one end. Light rays passing through the pinhole are projected as an image on a translucent plate. Students view this image through a hole in the other end and can change the image size by changing the length of the box.

- Demonstrates the behaviour of light
- Eisco type PH0592

**FREE SCIENCE & DESIGN & TECHNOLOGY POSTERS**  
Email [education@rapidonline.com](mailto:education@rapidonline.com) for your pack

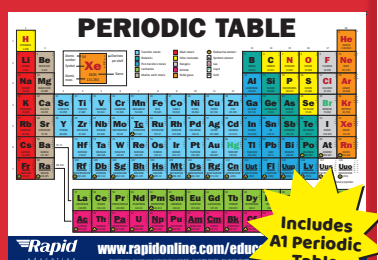
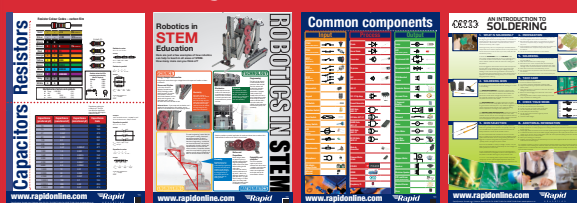

## Brass Slotted Mass Weights

A range of individual brass mass weights with slots, allowing them to be used on suitable mass hangers.

- Made from solid brass
- Each mass is marked for easy identification
- **Eisco PH0258G series**

We recommend using these masses with only Eisco mass hangers as other brands of mass hanger may not fit.



Mass	Order code	1+
1g	52-3402	£0.39
2g	52-3403	£0.42
5g	52-3404	£0.45
10g	52-3405	£0.49
20g	52-3406	£0.79
50g	52-3407	£1.49
100g	52-3408	£2.59

565570

## Brass Weight Hangers

A range of individual brass mass weight hangers for use with slotted masses.

- Made from solid brass
- Each hanger is marked for easy identification
- **Eisco PH0258H series**

We recommend using these hangers with only Eisco slotted masses as other brands of slotted masses may not fit.



Mass	Order code	1+
10g	52-3409	£0.65
20g	52-3410	£0.89
50g	52-3411	£1.49
100g	52-3412	£3.09

565571

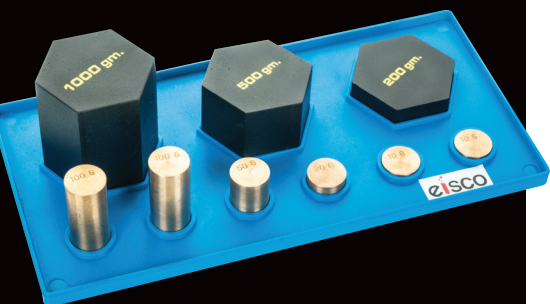

## Weighing Set Combination and Tray

A set of accurate steel and brass weights on a sturdy blue tray. The set allows the weighing of objects in 10g steps from 10g to 1990g.

- 3 steel weights
- 6 brass weights
- 1 each of 1kg, 500g, 200g, 50g & 20g
- 2 each of 10g & 10g
- **Eisco type PH0039AN8**

Order code  
52-3413  
**£16.95**

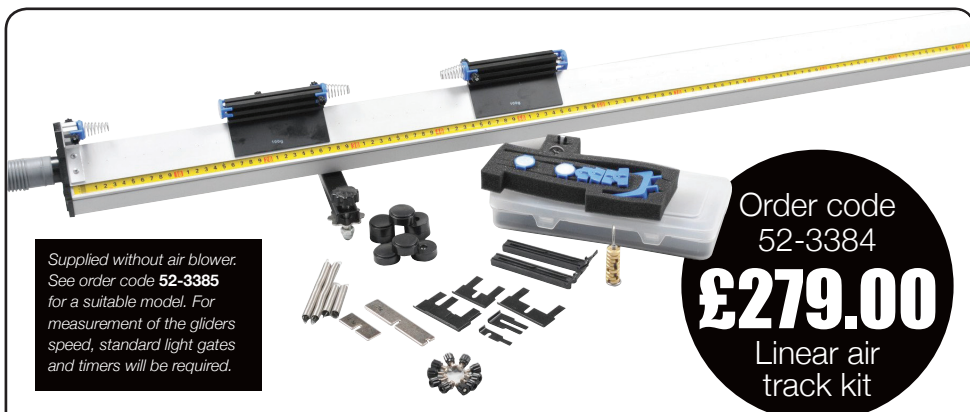

Supplied without air blower. See order code 52-3385 for a suitable model. For measurement of the gliders speed, standard light gates and timers will be required.

Order code  
52-3384  
**£279.00**  
Linear air track kit

## Linear Air Kit with Accessories

This linear air track kit is designed to provide a cost-effective, virtually friction-free environment for the study of all aspects of dynamics. It is particularly effective in the field of collisions, where conservation of momentum can be dramatically demonstrated. Air is blown through holes in the track by an air pump (sold separately) to produce a cushion of air under the sliders.

The kit contains everything required for a wide array of experiments covering velocity, force and acceleration, potential energy, kinetic energy, conservation of energy, SHM (Simple Harmonic Motion) as well as motion on level and inclined planes.

The air track is supplied with a comprehensive accessory pack to suit many types of interaction. The pack includes vehicles with mass attachments, catapults and buffers. The gliders are designed to accept standard slotted masses for additional loads.

- Cost-effective system for the study of all aspects of dynamics
- Ideal for classroom use
- Virtually friction-free for accurate demonstrations
- Designed to accept standard slotted masses
- Includes a comprehensive set of accessories
- Dimensions: 1620 x 180 x 320mm
- Weight: 11.3kg
- **Eisco type PH0362A**



Order code  
52-3385  
**£185.00**  
Air blower

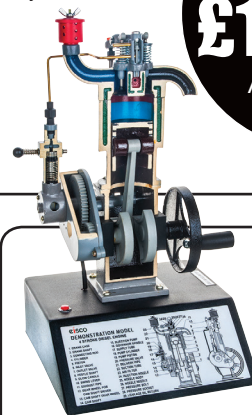

Order code  
52-3491  
**£64.95**

## Four Stroke Diesel Engine Model

The EISCO four-stroke Diesel engine model is hand-powered and shows the internal structure and operating principles of a water-cooled overhead-camshaft, four-stroke engine.

The camshaft is driven by a gear-train from the rear of the main crank. All functional components, valves, camshaft, rocker-arms, tappets, etc., are clearly demonstrated. The functioning of the fuel injection system is also represented. Cross sections of the carburettor and fuel supply are shown. Crank shaft, piston, valves and cams cycle through all stages of the four-stroke process as the hand-crank is rotated.

- Solidly constructed from aluminium and plastic
- Size 305 x 230 x 125mm
- Mounted on a 205 x 205 x 65mm base
- Label on base details all key components
- A lamp simulates the spark plug at the firing point
- **Eisco type PH0492**

Lamp requires 6 to 12V power source (not included).

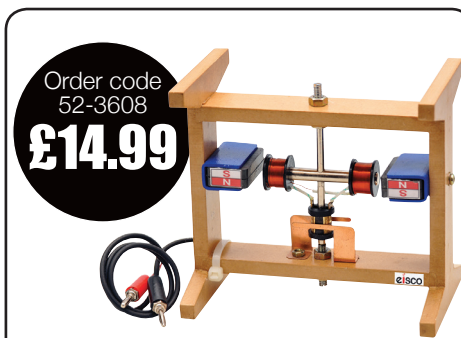

Order code  
52-3608  
**£14.99**

## Demonstration DC Motor

This demonstration DC motor has been specially designed to help students learn about electromagnetic forces in motors.

All parts are clearly visible and the polarity of the magnets can be reversed to change the direction of rotation. It can be used with a rheostat (not included) connected in series, to observe the change of speed caused by a change of current.

The commutator and sliding contacts (brushes) show how the polarity of the voltage is changed by the rotation of the rotor.

- Operates from a 1.5V DC supply or battery, not included
- **Eisco type PH1242**

# Spectrum Tubes, Holder & Power Supplies

A range of spectrum tubes, associated holders and power supplies, for use in spectral analysis experiments.

- Wide range of materials
- Power supplies and tubes are sold separately



Order code 52-3613  
**£149.99**  
PSU



Order code 52-3611  
**£21.95**  
Tube holder



Spectrum tubes  
**£12.99**  
Each

Type	Order code	1+
Tube holder	52-3612	<b>£21.95</b>
PSU 240V AC	52-3613	<b>£149.99</b>
<b>Spectrum tubes</b>		
Argon	52-3615	<b>£12.99</b>
Carbon dioxide	52-3616	<b>£12.99</b>
Helium	52-3617	<b>£12.99</b>
Hydrogen	52-3618	<b>£12.99</b>
Iodine vapour	52-3619	<b>£12.99</b>
Krypton	52-3620	<b>£12.99</b>
Neon	52-3621	<b>£12.99</b>
Nitrogen	52-3622	<b>£12.99</b>
Oxygen	52-3623	<b>£12.99</b>
Sulphur	52-3624	<b>£12.99</b>
Xenon	52-3625	<b>£12.99</b>



## Electrostatics Kit

This kit is ideal for small group experiments in electrostatics. The set is built around the special, dual-purpose electroscope, which in addition to being useful for general electrostatic experiments, is capable of performing measurements of the activity of weak radio-active materials. Positive and negative charges can be produced with the included acetate strips and woollen cloths.

A great variety of experiments can be performed including determining types of charge, measuring the amount of conducted or induced charge with the gold leaf electroscope or by using the polystyrene spheres as hollow conductors, and using the proof plane to investigate the distribution of charges on conductors.

- **Kit includes:**
- 1x electroscope with top plate and hook electrode
- 1x packet of gold leaves
- 4x metallised polystyrene spheres
- 1x reel of very fine nylon thread
- 2x polythene plate, 75mm square
- 1x electrophorus plate, 50mm diameter with insulating handle
- 1x proof plane
- 2x aluminium calorimeters
- 1x cellulose acetate strip
- 1x polythene strip with woollen rubber
- 1x stirrup for suspending strip
- **Eisco type PH0900**

Order code 52-3634  
**£21.95**

## Electroscope Kit

This electroscope kit is ideal for electrostatic charge experiments and other related studies such as electrostatic induction, the nature of charge in a body, Faraday's ice pail experiment, etc.

- **Kit includes:**
- 2x flask-type electroscopes
- 2x discs
- 2x terminals
- 1x Faraday's ice pail
- Spare foil leaf included
- Supplied complete with instructions
- **Eisco type PH0901**

Order code 52-3637  
**£13.95**



## Gold Leaf Electroscope

This gold-leaf electroscope is great for hands-on experience with electrostatic principles in physics classrooms and labs. When an electrostatic charge is induced or transferred to the electroscope, the charge causes a thin piece of gold leaf to be repelled away from its mount. The resultant deflection of the leaf shows the presence of an electrostatic charge and the angle of the leaf can be used as a measure of the charge.

The solidly constructed sheet anodised aluminium frame of the electroscope is mounted on a plastic base. Front glass window slides up to allow the insertion of ionizing material into chamber. A transparent scale is attached inside the chamber to measure the deflection of the gold leaf.

- Supplied with two gold leaf sheets
- Fitted with 4mm socket
- When assembled, the electroscope measures 165 x 95 x 71mm
- **Eisco type PH0916B**



Electroscope  
Order code 52-3640  
**£14.49**

Gold leaves pack of 6  
Order code 52-3641  
**£2.79**

*Note: the gold-leaf does not come pre-attached to the electroscope. Instructions on how to properly attach the gold-leaf to the conducting rod are included in the Experiment Guide. Replacement gold leaf is available separately.*

## Friction Rods

A range of rods of differing materials for use in physics projects and electrostatics.

- Length 300mm

Material	Order code	1+
Ebonite	52-3633	<b>£1.69</b>
Glass	52-3638	<b>£0.99</b>
Perspex	52-3639	<b>£2.79</b>
Nylon	52-3642	<b>£1.45</b>
Polythene	52-3643	<b>£1.79</b>





**Order code 52-3311**  
**£3.95**

### Bi-Metal Strip

A single-piece non-jointed bimetallic strip with a wooden handle.

When heated, the strip bends showing that one metal has expanded more than the other. The strip straightens again when cooled.

- Single piece non-jointed bimetallic strip
- An improved version of the riveted form
- Metals are copper and steel
- The metals are distinct and visible
- **Eisco type PH0383**



**Order code 52-3350**  
**£9.49**

### Bar and Gauge Expansion Demonstration Apparatus - Superior

An apparatus for demonstrating expansion in metals, comprising a metal bar mounted on a rod with an insulated handle and a U-shaped metal gauge plate.

At room temperature, the metal bar fits inside the jaws of the gauge plate. When the rod is heated, it expands and no longer fits into the gauge plates jaws.

- **Eisco type PH0378B**



**Order code 52-3445**  
**£4.95**

### Ball and Ring Expansion Demonstration Apparatus Set

An apparatus for demonstrating expansion in metals, comprising a brass ball and a brass ring, each mounted on a rod with an insulated handle.

At room temperature, the metal ball fits through the ring. When the ball is heated, it expands and no longer fits through the ring.

- Ball diameter 19mm
- **Eisco type PH0374D**



**Order code 52-3333**  
**£6.19**

### Thermal Conductivity of Metal Apparatus

Comprising strips of copper, iron, aluminium and brass fixed to a wooden ring, this economical apparatus demonstrates the varying speeds of heat conduction along differing metal strips.

The outer ends of the metal strips have small recesses for holding paraffin wax. By heating the centre where the four strips meet, the wax can be seen to melt at different times, governed by the conductivity of the four different metals.

- Strips of copper, iron, aluminium and brass
- Wooden ring
- **Eisco type PH0400B**



**Thermal Conductivity Metal Rods**

These metal rods are ideal for thermal conductivity experiments.

- Metal rods for thermal conductivity experiments
- Approximately 300mm long x 3mm diameter
- Individual metal types supplied in **packs of 10**
- Assorted metal types supplied in **packs of 6**

Material	Order code	1+
Assorted (6)	52-3352	<b>£4.99</b>
Aluminium (10)	52-3656	<b>£6.95</b>
Brass (10)	52-3657	<b>£8.95</b>
Copper (10)	52-3351	<b>£8.49</b>
Iron (10)	52-3659	<b>£6.19</b>
Lead (10)	52-3660	<b>£8.29</b>
Zinc (10)	52-3662	<b>£8.95</b>

### Specific Heat Cylinder Sets

Sets of six metal cylinders for use in specific heat experiments. The sets both contain one cylinder of copper, lead, brass, zinc, iron and aluminium. One set has cylinders of the same length, the other has cylinders of varying length.

- Metal cylinders for specific heat experiments
- Cylinders have a drilled hole for suspension
- Supplied in **sets of six with a wooden base**



**Order code 52-3347**  
**£2.95**  
115x90mm

**Order code 52-3348**  
**£7.29**  
225x125mm

### Displacement Vessels

Displacement vessels with spout, for specific gravity experiments.

- Seamless
- Flared top edge
- Angled spout for convenient overflow collection
- Material: metal (tin)



**Order code 52-3648**  
**£21.95**  
Various lengths

**Order code 52-3663**  
**£14.95**  
Same length





### Leslie's Cubes

These Leslie's cubes have sides with different surface finishes. They are ideal for use in experiments to show how objects emit and absorb heat.

In use, the apparatus is filled with water which is maintained at boiling point by a low Bunsen burner flame. Infra-red sensors, etc., can be used to compare the relative radiant heat output from each of the four faces.

- Top hole for filling and emptying
- Bung for thermometer
- **Eisco PH0411 series**

Size	Material	Order code	1+
100mm	Copper	52-3650	£13.95
130mm	Tin	52-3649	£7.99

565658



Order code  
52-3698  
**£14.95**  
Set of 6

### Cubes for Density Investigation Set

A set of six 20mm cubes fitted with a hook for easy handling. Each cube by definition has identical volume but widely differing weight.

Materials include: brass, lead, zinc, copper, aluminium and iron.

- Supplied as a **set of 6**
- **Eisco type PH0108P**



Order code  
52-3702  
**£24.95**  
Set of 9

### Specimen Density Set

A set of 25mm cubes of various materials for density investigation. Each cube by definition has identical volume but widely differing weight.

The set includes: brass, iron, copper, aluminium, hardwood, softwood, nylon, PVC and acrylic.

- 25mm cubes
- Wooden storage box
- Supplied as a **set of 9**
- **Eisco type PH0109A**



Order code  
52-3342  
**£21.49**



Tuning forks  
**£3.89**  
Each

### Tuning Forks

A range of superior quality aluminium tuning forks with plain shanks and round stems.

- Ideal for school, college and laboratory use
- **Eisco PH0737 series**

Note	Frequency	Order code
C	256Hz	52-3453
D	288Hz	52-3454
F	341Hz	52-3455
G	384Hz	52-3456
A	426Hz	52-3457
B	480Hz	52-3458
C	512Hz	52-3459

565658

Order code  
52-3446  
**£12.99**

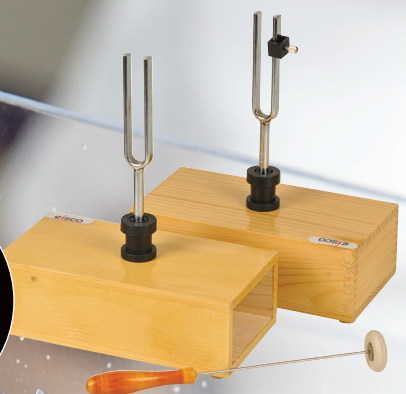

### Resonance Tuning Forks with Hammer

This apparatus can be used for demonstrating the production of beat frequencies. It is comprised of two nickel-plated tuning forks mounted on individual sound boxes. The two forks both produce an 'A' note (440Hz) when struck with the mallet. One fork is provided with an adjustable mass, by means of which the frequency of that fork may be shifted from the nominal 440Hz. When both forks are sounded at the same time, a clearly audible 'beat' is produced, its rate depending upon the difference in frequency between the two forks.

- Used to hear dissonance
- One fork adjustable
- Supplied complete with 2x tuning forks, 1x adjustable mass, 2x bases and mallet
- **Eisco type PH0742A**

### Resonance Apparatus with Telescopic Brass Tube

This resonance apparatus is comprised of two brass tubes that can telescope into each other, allowing the column of air within the tube to be varied between 300 and 530mm.

- Outer tube fits into base
- **Eisco type PH0718B**

Order code  
52-3436  
**£25.95**



### Tuning Forks Set

An eight-piece set of nickel-plated tuning forks with plain shanks. The forks are marked with their individual frequencies: C (256Hz), D (288Hz), E (320Hz), F (341Hz), G (384Hz), A (426Hz), B (480Hz) and C (512Hz).

- 8-piece set
- Supplied in wooden storage case
- **Eisco type PH0738B**



- Simple sonometer
- Steel wires
- Three bridges
- **Eisco type PH0726**

**Order code 52-3341**  
**£39.95**

## Sonometer

A simple sonometer for the investigation of the performance and characteristics of vibrating wires under tension. The sonometer consists of a wooden baseboard 980 x 90mm mounted on four feet. At one end of the base are two 50 Newton spring balances with hooks, and at the other end are two corresponding wrest pins for tensioning. It is supplied complete with two 30 SWG steel wires one metre long. Also provided are three bridges: one large to span both wires and two small ones for the individual wires.

**Order code 52-3701**  
**£5.99**

## Minute Timer

A simple and economical timer that measures one minute intervals up to one hour. After setting the desired time interval, a signal indicates the end of the time period.

- **Eisco type PH0361**

**Order code 52-3494**  
**£3.49**

## Tally Counter

A hand-held 4-digit tally counter in an attractive chrome-finished case. Each press of the top button increases the count by 1.

- Positive click action
- Reset to zero via thumb wheel on side
- Reset wheel can be removed to prevent unauthorised resetting
- **Eisco type BI0346**

## Hand Protector

Using this silicon rubber glove, both cold or hot items, like flasks, bottles and beakers, can be safely and securely handled.

- Studded surface for positive grip
- Maximum temperature 250°C
- Pockets for fingers and thumb fit all hand sizes
- **Eisco type CH0616HP**

**Order code 52-3597**  
**£10.95**

## Clear Vented Safety Glasses

These safety glasses can be worn alone, or are perfect for fitting over most prescription spectacles.

- Vented to prevent fogging
- UV protected
- Lightweight polycarbonate
- Impact resistant lens
- CE marked
- Conform to ANSI Z87.1 2010 side-shield protection
- **Eisco type CH0619A**

**Order code 52-3596**  
**£1.49**

## Black Rubber Bib Aprons

Basic black rubber aprons, perfect for the chemistry laboratory.

The aprons are comfortable and flexible, waterproof and resistant to most chemicals likely to be used by students.

- Available in medium or large sizes
- Medium: width 685mm (27in.), length 915mm (36in.)
- Large: width 685mm (27in.), length 1065mm (42in.)
- **Eisco RBAP series**

**Aprons £5.99 Each**

Size	Order code
Medium	<b>52-3595</b>
Large	<b>52-3594</b>

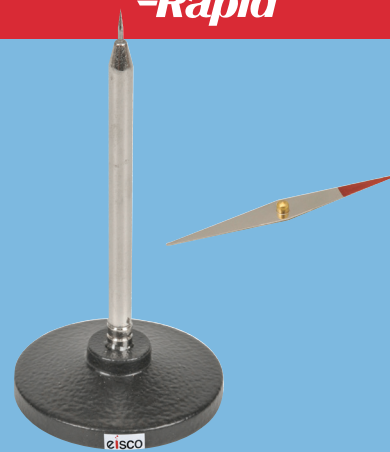

## Magnetic Needle Stand and Needles

A range of magnetic needles and a suitable low-friction stand for use in the study of magnetic fields and compasses.

- Stand height 110mm
- Range of needle sizes
- All parts sold separately

Type	Order code	1+
Stand	<b>52-3318</b>	<b>£2.95</b>
50mm needle	<b>52-3319</b>	<b>£0.79</b>
75mm needle	<b>52-3320</b>	<b>£0.79</b>
100mm needle	<b>52-3321</b>	<b>£1.29</b>

**Order code 52-3695**  
**£0.29**

## Basic Plotting Compass 16mm

A basic 16mm diameter plotting compass marked with the principal compass points.

The compasses provide a simple, visible method of demonstrating and mapping magnetic fields in a classroom environment.

- Glass face
- Aluminium case
- Diameter: 16mm
- **Sold singly**
- **Eisco type PH0820A**



## Iron Filings

These iron filings are ideal for magnetic field mapping and a host of other experiments with magnetism.

- Available in course or fine grades
- Supplied in **250g plastic jars**
- **Eisco PH0799 series**

Grade	Order code	1+
Course	<b>52-3696</b>	<b>£2.99</b>
Fine	<b>52-3697</b>	<b>£1.49</b>

# LABORATORY Essentials

## Splints – Pack of 100

Only

**£3.57**

Order code  
52-0135



## Goggles

From only

**£1.05**

Order code  
87-3104



## Goggles – Classpack of 20

Only

**£22.70**

Order code  
87-3103



## Lab Coats

From only

**£12.75**

Order code  
52-1194



# Deluxe Handheld Digital Microscope

£39.99

Order code  
52-9657



 **CELESTRON**<sup>®</sup>

CELESTRON GLOBAL LIMITED

The Celestron 44302-B-CGL Deluxe Hand-held Digital Microscope is an easy to use, low power microscope. With powers of 10x to 40x, it's ideal for viewing stamps, coins, bugs, plants, rocks, skin, gems, circuit boards, and more. With the higher power magnifications, you can even view traditional microscope slides.

- Powered by USB 2.0
- Built-in ZMP digital camera with SD video
- 10 to 40x magnification
- 6 LED ring illuminator
- Windows software (supplied)



**Rapid**  
education

**Orderline: 01206 751166 Fax: 01206 751188**  
**Email : [education@rapidonline.com](mailto:education@rapidonline.com)**

Rapid Education, Severalls Lane, Colchester, Essex C04 5JS

Rapid Education part of the  **CONRAD** Group

E&OE. All content and images are subject to copyright and cannot be reproduced in any form without the express permission of Rapid Electronics Limited. Prices may vary, see website for up-to-date prices. For full terms & conditions visit [www.rapidonline.com/terms](http://www.rapidonline.com/terms)

M0727 11/17



All prices  
exclude VAT



MIX  
Paper from  
responsible sources  
FSC® C017177